

# North Burnett Regional Council Subordinate Local Law No. 1 (Administration) 2011

## Contents

---

<b>Part 1</b>	<b>Preliminary.....</b>	<b>3</b>
	1 Short title.....	3
	2 Purpose and how it is to be achieved.....	3
	3 Authorising local law.....	3
	4 Definitions.....	3
<b>Part 2</b>	<b>Approvals for prescribed activities.....</b>	<b>4</b>
	5 Prescribed activities that do not require an approval—Authorising local law, s 6(3).....	4
	6 Categories of prescribed activities for the purposes of maximum penalties— Authorising local law, s 6(4).....	4
	7 Approvals that are non-transferable—Authorising local law, s 15(2).....	4
	8 Prescribed complementary accommodation—Authorising local law, schedule.....	4
	9 State-controlled roads to which the local law applies—Authorising local law, schedule 1.....	5
	10 Public place activities that are prescribed activities—Authorising local law, schedule 2, part 2.....	5
	11 Matters regarding prescribed activities—Authorising local law, ss 6(3), 8(2)(a),9(1)(d), 10(3), 12, 13(a), 14(1)(a).....	5
<b>Schedule 1</b>	<b>Prescribed activities that do not require an approval under the authorising local law.....</b>	<b>7</b>
<b>Schedule 2</b>	<b>Categories of prescribed activities for the purposes of maximum penalties.....</b>	<b>8</b>
<b>Schedule 3</b>	<b>Categories of approval that are non-transferable.....</b>	<b>9</b>
<b>Schedule 4</b>	<b>Authorised works on roads.....</b>	<b>10</b>
<b>Schedule 5</b>	<b>Public place activities that are prescribed activities.....</b>	<b>12</b>
<b>Schedule 6</b>	<b>Alteration or improvement to local government controlled areas and roads.....</b>	<b>15</b>
<b>Schedule 7</b>	<b>Commercial use of local government controlled areas and roads.....</b>	<b>22</b>
<b>Schedule 8</b>	<b>Establishment or occupation of a temporary home.....</b>	<b>26</b>
<b>Schedule 9</b>	<b>Installation of temporary advertising devices.....</b>	<b>29</b>
<b>Schedule 10</b>	<b>Keeping of animals.....</b>	<b>37</b>
<b>Schedule 11</b>	<b>Operation of camping grounds.....</b>	<b>41</b>
<b>Schedule 12</b>	<b>Operation of cane railways.....</b>	<b>45</b>
<b>Schedule 13</b>	<b>Operation of caravan parks.....</b>	<b>46</b>
<b>Schedule 14</b>	<b>Operation of cemeteries.....</b>	<b>52</b>
<b>Schedule 15</b>	<b>Operation of public swimming pools.....</b>	<b>56</b>

---

<b>Schedule 16</b>	<b>Operation of shared facility accommodation.....</b>	<b>67</b>
<b>Schedule 17</b>	<b>Operation of temporary entertainment events.....</b>	<b>72</b>
<b>Schedule 18</b>	<b>Undertaking regulated activities regarding human remains— (a) disturbance of human remains buried outside a cemetery.....</b>	<b>76</b>
<b>Schedule 19</b>	<b>Undertaking regulated activities regarding human remains— (b) burial or disposal of human remains outside a cemetery.....</b>	<b>78</b>
<b>Schedule 20</b>	<b>Undertaking regulated activities regarding human remains— (c) disturbance of human remains in a local government cemetery.....</b>	<b>80</b>
<b>Schedule 21</b>	<b>Undertaking regulated activities on local government controlled areas and roads— (a) driving or leading of animals to cross a road .....</b>	<b>82</b>
<b>Schedule 22</b>	<b>Undertaking regulated activities on local government controlled areas and roads— (b) depositing of goods or materials .....</b>	<b>84</b>
<b>Schedule 23</b>	<b>Undertaking regulated activities on local government controlled areas and roads— (c) undertaking of a public place activity prescribed by subordinate local law.....</b>	<b>86</b>
<b>Schedule 24</b>	<b>Use of bathing reserves for training, competitions etc.....</b>	<b>90</b>
<b>Schedule 25</b>	<b>Parking contrary to an indication on an official traffic sign regulating parking by time or payment of a fee.....</b>	<b>91</b>
<b>Schedule 26</b>	<b>Parking in a loading zone by displaying a commercial vehicle identification label.....</b>	<b>92</b>
<b>Schedule 27</b>	<b>Carrying out works on a road or interfering with a road or its operation.....</b>	<b>93</b>
<b>Schedule 28</b>	<b>Gates and Grids.....</b>	<b>95</b>
<b>Schedule 29</b>	<b>Dictionary.....</b>	<b>104</b>
	<b>Certification by Chief Executive Officer.....</b>	<b>117</b>

## Part 1 Preliminary

### 1. Short title

This subordinate local law may be cited as *Subordinate Local Law No. 1 (Administration) 2011*.

### 2. Purpose and how it is to be achieved

- (1) The purpose of this subordinate local law is to supplement *Local Law No. 1 (Administration) 2011*, which provides for a legal and procedural framework for the administration, implementation and enforcement of the local government's local laws, subordinate local laws and other regulatory powers, and for miscellaneous administrative matters.
- (2) The purpose is to be achieved by providing for—
  - (a) various matters regarding the granting of approvals for prescribed activities; and
  - (b) further specification of the definitions relevant to various prescribed activities.

### 3. Authorising local law

The making of the provisions in this subordinate local law is authorised by *Local Law No. 1 (Administration) 2011* (the **authorising local law**).

### 4. Definitions

- (1) Particular words used in this subordinate local law have the same meaning as provided for in the authorising local law.
- (2) In this subordinate local law—

**standard public liability insurance condition** means that the approval holder must—

  - (a) for the duration of the term of the approval, maintain in full force and effect a standard public liability insurance policy—
    - i) in the joint names of the approval holder and the local government; and
    - ii) covering their respective rights, interests and liabilities to third parties in respect of accidental death of, or accidental bodily injury to, persons or accidental damage to property; and
    - iii) for an amount of no less than \$10 million for any single event; and
  - (b) prior to the commencement of the activity, provide the local government with a certificate of currency for the standard public liability insurance policy; and

- (c) indemnify the local government and the State against all actions, proceedings, claims, demands, costs, losses, damages and expenses which may be brought against, or made upon, the local government or the State as a result of the activity.

## **Part 2 Approvals for prescribed activities**

### **5. Prescribed activities that do not require an approval—Authorising local law, s 6(3)**

For section 6(3) of the authorising local law, it is declared that section 6(2) of the authorising local law does not apply to the prescribed activities listed in schedule 1.

### **6. Categories of prescribed activities for the purposes of maximum penalties—Authorising local law, s 6(4)**

For section 6(4) of the authorising local law, it is declared that—

- (a) the prescribed activities listed in part 1 of schedule 2 are category 1 activities; and
- (b) the prescribed activities listed in part 2 of schedule 2 are category 2 activities; and
- (c) the prescribed activities listed in part 3 of schedule 2 are category 3 activities.

### **7. Approvals that are non-transferable—Authorising local law, s 15(2)**

For section 15(2) of the authorising local law, it is declared that the categories of approval listed in schedule 3 are non-transferable.

### **7A Authorised works on roads—Authorising local law, s 7A(1)**

For section 7A(1) of the authorising local law, it is declared that in the circumstances specified in schedule 4, a person does not require the local government's approval to—

- (a) carry out works on a road; or
- (b) interfere with a road or its operation.

### **8. Prescribed complementary accommodation—Authorising local law, schedule 1**

For the purposes of the definition of **complementary accommodation** in schedule 1 of the authorising local law, the following accommodation is prescribed as appropriate for caravan parks—

- (a) converted railway carriages.

**9. State-controlled roads to which the local law applies—Authorising local law, schedule 1**

For the purposes of the definition of **road** in schedule 1 of the authorising local law, all State-controlled roads within the local government area are roads to which the following local laws apply, unless otherwise provided in the local law—

- (a) the authorising local law, in relation to the following prescribed activities only—
  - i) commercial use of local government controlled areas and roads; and
  - ii) installation of advertising devices; and
- (b) *Subordinate Local Law No. 4 (Local Government Controlled Areas, Facilities and Roads) 2011*, schedule 1, row 1, in relation to the prohibited activity, 'Parking a vehicle, vessel or trailer for the primary purpose of advertising the vehicle, vessel or trailer for sale'.

**10. Public place activities that are prescribed activities—Authorising local law, schedule 2, part 2**

For the purposes of paragraph (c) of the definition of **undertaking regulated activities on local government controlled areas and roads** in part 2 of schedule 2 of the authorising local law, the undertaking of a public place activity listed in schedule 5 is a prescribed activity.

**11. Matters regarding prescribed activities—Authorising local law, ss 6(3), 8(2)(a), 9(1)(d), 10(3), 12, 13(a), 14(1)(a)**

- (1) For each prescribed activity, a schedule prescribes the matters specified in this section for the prescribed activity named in section 1 of the schedule.
- (2) For section 6(3) of the authorising local law, it is declared that section 6(2) of the authorising local law does not apply to an activity stated in section 2 of the schedule relating to the prescribed activity.
- (3) For section 8(2)(a) of the authorising local law, the documents and materials that must accompany an application for approval for the prescribed activity are stated in section 3 of the schedule relating to the prescribed activity.
- (4) For section 9(1)(d) of the authorising local law, the local government may only grant an approval for a prescribed activity if it is satisfied the proposed operation and management of the activity would be consistent with the additional criteria prescribed in section 4 of the schedule relating to the prescribed activity.
- (5) For section 10(3) of the authorising local law, the conditions that must be imposed on an approval for a prescribed activity are stated in section 5 of the schedule relating to the prescribed activity.

- (6) For section 10(3) of the authorising local law, the conditions that will ordinarily be imposed on an approval for a prescribed activity are stated in section 6 of the schedule relating to the prescribed activity.
- (7) For section 13(a) of the authorising local law, the term of an approval for a prescribed activity is provided for in section 7 of the schedule relating to the prescribed activity.
- (8) For section 14(1)(a) of the authorising local law, the further term for renewal or extension of an approval for a prescribed activity is provided for in section 8 of the schedule relating to the prescribed activity.
- (9) For section 12 of the authorising local law, in Table 1 of the schedule relating to a prescribed activity—
  - (a) column 1 lists the application requirements for which the local government may accept as evidence the certificate of a third party certifier; and
  - (b) column 2 lists the individuals or organisations that are declared to be third party certifiers for the corresponding application requirement in column 1; and
  - (c) column 3 lists the qualifications that are necessary for an individual or organisation to be a third party certifier for the corresponding application requirement in column 1.

---

**Schedule 1      Prescribed activities that do not require an  
approval under the authorising local law**

section 5

*This schedule has been intentionally left blank.*

## **Schedule 2                    Categories of prescribed activities for the purposes of maximum penalties**

section 6

### **Part 1                            Category 1 activities**

- 1 alteration or improvement to local government controlled areas and roads;
- 2 commercial use of local government controlled areas and roads;
- 3 establishment or occupation of a temporary home;
- 4 installation of advertising devices;
- 5 keeping of animals;
- 6 undertaking regulated activities on local government controlled areas and roads;
- 7 use of bathing reserves for training, competitions etc.;

### **Part 2                            Category 2 activities**

- 8 operation of camping grounds;
- 9 operation of caravan parks;
- 10 operation of cemeteries;
- 11 operation of public swimming pools;
- 12 operation of shared facility accommodation;
- 13 operation of temporary entertainment events;
- 14 undertaking regulated activities regarding human remains;

### **Part 3                            Category 3 activities**

- 15 operation of cane railways;



## **Schedule 3            Categories of approval that are non-transferable**

section 7

- 1    establishment or occupation of a temporary home;
- 2    keeping of animals;
- 3    temporary entertainment events;
- 4    operation of a caravan park;
- 5    activities on local government controlled facilities, areas and roads;
- 6    commercial recreational activities.

## Schedule 4      **Authorised works on roads**

section 7A

- (1) The installation of kerbside numbering provided—
  - (a) The installer has, as a minimum, standard public liability insurance; and
  - (b) signage is in accordance with the Manual of Uniform Traffic Control Devices; and
  - (c) the owner of the property accepts responsibility for the ongoing maintenance of the numbering; and
  - (d) the owner of the property accepts that the local government will not be responsible for reinstatement costs associated with replacement of kerb and channel or damage resulting from the local government's street sweeper; and
  - (e) the numbering is located adjacent to the property vehicle crossing; and
  - (f) black numerals are used on a white reflective 'long life' or similar background which is rectangular, using paint specifically designed for concrete surfaces with powdered glass beads or approved equivalent, applied giving total reflective effect; and
  - (g) numeral size is 75mm high.
- (2) The installation of a property name sign on a rural property adjacent to and with direct access to the road provided the sign is—
  - (a) erected on one or two posts which are not stronger than circular hollow sections of 60mm overall diameter and 3.6mm wall thickness; and
  - (b) located not less than 9 metres from the edge of the nearest traffic lane.
- (3) The installation of a roadside memorial provided <sup>1</sup>—
  - (a) the dimensions are less than Height 750mm, Width 500mm, and Depth 400mm (below ground level); and the memorial is not located—
    - i) on a traffic island, median, roundabout; or
    - ii) where it may interfere with any traffic control device; or
    - iii) where it will interfere with the safe movement of pedestrian or vehicular traffic, and
  - (c) the memorial does not cause damage to any services; and

---

<sup>1</sup> Any memorial installed upon state controlled roads must comply with the requirements specified by the state government.

- 
- (d) council reserves the right to remove any memorial at it's discretion
  - (4) Maintenance or repair of a driveway access or vehicle crossover, where the works are carried out in accordance with the local government's current standards and conditions for the installation of driveway accesses or vehicle crossovers.
  - (5) Repair or maintenance of an existing approved gate, grid or other piece of infrastructure, where the works are carried out in accordance with the requirements in section 6(4) of schedule 27 of this subordinate local law.
  - (6) A mail box in an area serviced by a rural mailed serviced delivery, provided the mailbox is—
    - (a) not more than 50 litres in capacity; and
    - (b) erected on one or two posts with a circular hollow section of less than 60mm overall diameter and 3.6mm wall thickness; and
    - (c) located not less than 3.5 metres from the edge of the nearest traffic lane.

## Schedule 5      Public place activities that are prescribed activities

section 10

<p style="text-align: center;"><b>Column 1</b> <b>Local government controlled road or area</b></p>	<p style="text-align: center;"><b>Column 2</b> <b>Prescribed Activity</b></p>
<p>The whole of the local government area.</p>	<p>Distribution of Business Advertising Publications</p> <p>(a) If a business publication is distributed in a public place the following persons are taken to have distributed the business advertising publication—</p> <p>i) any person who actually distributes the business advertising publication;</p> <p>ii) any operator or person in control of a business, commercial, trade activity or premises publicised by the distribution of the business advertising publication</p> <p>Touting or Soliciting</p> <p>(a) If a business publication is distributed in a public place the following persons are taken to have distributed the business advertising publication—</p> <p>i) any person who actually touts;</p> <p>ii) any operator or person in control of a business, commercial, trade activity or premises publicised by the touting.</p> <p>Activities or conduct</p> <p>(a) formal or organised sporting or recreation activities;</p> <p>(b) social or community events for more than 50 people (more than</p>

	<p>100 people in parks);</p> <ul style="list-style-type: none"> <li>(c) research and scientific investigation;</li> <li>(d) marriage ceremony or marriage reception;</li> <li>(e) public meeting, public demonstration or public address;</li> <li>(f) public education information and interest display or events;</li> <li>(g) life saving competition or training or other aquatic activity;</li> <li>(h) hiring of equipment;</li> <li>(i) stage events, markets, festivals or concerts.</li> </ul> <p>Busking</p> <ul style="list-style-type: none"> <li>(a) Performance of any entertainment or use of any sound amplifying equipment. Erect, remove or alter a building, structure, path, facility, sign, fence, notice, equipment or any measure of access control and security.</li> <li>(b) Erect an awning or balcony over a footpath</li> </ul> <p>Bring non-native fauna</p> <p>Fundraising</p>
<p>Cemeteries in the Local Government Area</p>	<p>Bury or inter a deceased person</p> <p>Construct or erect a private vault or columbarium</p> <p>Perform any customary or religious ceremony in the burial of the deceased person in accordance with a particular custom or religious denomination to which the deceased belonged (including personally closing or covering the grave of the deceased person other than by an</p>

	<p>undertaker)</p> <p>Have any animal in the cemetery as part of the ceremony</p> <p>Conduct a funeral other than by an undertaker</p> <p>Erect or install a memorial</p>
--	---

## Schedule 6            Alteration or improvement to local government controlled areas and roads

section 11

### 1.     Prescribed activity

Alteration or improvement to local government controlled areas and roads.<sup>2</sup>

### 2.     Activities that do not require an approval under the authorising local law

(1)    Section 6(2) of the authorising local law does not apply if—

- (a)    the operation of the prescribed activity is installing, changing, planting, removing or clearing a footpath garden; and<sup>3</sup>
- (b)    the undertaking of the prescribed activity complies with the minimum standards prescribed in subsections (2) to (9) inclusive.

(2)    The undertaking of the prescribed activity must not adversely affect the amenity of the area in which the prescribed activity is undertaken.

(3)    The footpath garden must—

- (a)    be aesthetically pleasing and sympathetic with the image of the local government area; and
- (b)    comprise annual flowering plants or ground cover having a height not more than 1000mm above ground level; and

---

<sup>2</sup> See *Local Law No. 1 (Administration) 2011*, schedule 2, part 2, **alteration or improvement to local government controlled areas and roads** means—

- 1        *Alteration or improvement to local government controlled areas and roads* means—
  - (a)    installing, changing, damaging or removing a structure in a local government controlled area or on a road; or
  - (b)    planting, clearing or damaging of vegetation in a local government controlled area or on a road.
- 2        *Alteration or improvement to local government controlled areas and roads* does not include an alteration or improvement—
  - (a)    that constitutes development under the Planning Act; or
  - (b)    for which a tree clearing permit is required under the *Vegetation Management Act 1999*; or
  - (c)    that involves a network connection; or
  - (d)    for which written approval of the local government is required under section 75 of the Act.

<sup>3</sup> Note, alteration or improvement to local government controlled areas and roads does not include an alteration or improvement for which written approval of the local government is required under section 75 of the Act. See schedule 2, part 2 of the authorising local law and *Subordinate Local Law No. 1.15 (Carrying Out Works on a Road or Interfering with a Road or its Operation) 2011*.

- (c) not include any plant which is poisonous or has thorns.
- (4) The undertaking of the prescribed activity must not unduly interfere with the proper use of the footpath.
- (5) The physical characteristics of the footpath on which the prescribed activity is, or is to be, undertaken, must be suitable for the prescribed activity.
- (6) The undertaking of the prescribed activity must not cause nuisance, inconvenience or annoyance to—
  - (a) the occupier of any premises which adjoins the location of the prescribed activity; or
  - (b) vehicular traffic; or
  - (c) pedestrian traffic.
- (7) The person undertaking the prescribed activity must—
  - (a) limit the undertaking of the prescribed activity to the footpath immediately adjacent to premises which are owned or occupied by the person; and
  - (b) keep and maintain a clear unobstructed corridor for pedestrian and cycle traffic on the footpath having dimensions not less than the dimensions shown in diagram 1; and
  - (c) regularly clean and maintain the area on which the prescribed activity is undertaken; and
  - (d) ensure that no part of the prescribed activity is undertaken—
    - i) otherwise than as shown in diagram 1; or
    - ii) less than 5m from a bus zone; and
  - (e) not deposit goods or materials on the footpath for storage purposes for a period longer than 24 hours; and
  - (f) not undertake the prescribed activity in a manner which obstructs—
    - i) the line of sight of any vehicular or pedestrian traffic on the road or footpath on which the prescribed activity is, or is to be, undertaken; or
    - ii) the view of any user of the footpath on which the prescribed activity is, or is to be, undertaken, or any road adjacent to the footpath; and



- (g) not undertake the prescribed activity in a manner which causes, or may cause, a possible hazard to vehicular or pedestrian traffic on the footpath on which the prescribed activity is, or is to be, undertaken, or any road adjacent to the footpath; and
- (h) not undertake the prescribed activity in a manner which restricts the line of sight of a driver—
  - i) crossing the footpath on which the prescribed activity is, or is to be, undertaken; or
  - ii) using any road adjacent to the footpath on which the prescribed activity is, or is to be, undertaken; and
- (i) not undertake the prescribed activity using a structure that is, or could be, a hazard if struck by vehicular or pedestrian traffic; and
- (j) replace each structure used in the undertaking of the prescribed activity with a similar structure which is in good condition if the structure cannot be made effective by cleaning or repairing the structure; and
- (k) if a structure used in the undertaking of the prescribed activity is damaged or otherwise no longer in good condition, either refurbish the structure to new condition, or replace the structure; and
- (l) in the undertaking of the prescribed activity, not park or place any machinery or equipment, or store any materials, in a position where the machinery, equipment or materials may create a hazard, obscure a sign, or block the line of sight of approaching vehicular or pedestrian traffic; and
- (m) if machinery, equipment or materials are used in the undertaking of the prescribed activity—promptly after completion of the prescribed activity, dismantle and remove from the footpath all machinery, equipment and materials used in the undertaking of the prescribed activity; and
- (n) contact each service provider and ascertain the location of all infrastructure of the service provider which may be affected by the undertaking of the prescribed activity; and
- (o) ensure that the undertaking of the prescribed activity does not damage or interfere with the infrastructure of any service provider; and
- (p) if the undertaking of the prescribed activity damages or interferes with the infrastructure of a service provider—promptly notify each of the service provider and the local government;

and

- (q) if a person undertaking the prescribed activity damages or interferes with the infrastructure of a service provider—pay to the service provider reasonable compensation for the damage or interference to the infrastructure of the service provider; and
- (r) not undertake the prescribed activity in a manner which—
- i) results in a risk or distraction to the driver of a motor vehicle; or
  - ii) compromises vehicular or pedestrian safety on a road, or at an intersection.
- (8) If the person undertaking the prescribed activity discontinues the prescribed activity, the person must promptly reinstate the footpath to its condition prior to the commencement of the prescribed activity.
- (9) If the undertaking of the prescribed activity on the footpath includes the planting or installation of vegetation on the footpath—the person undertaking the prescribed activity must transfer ownership of the vegetation to the local government.

Diagram 1

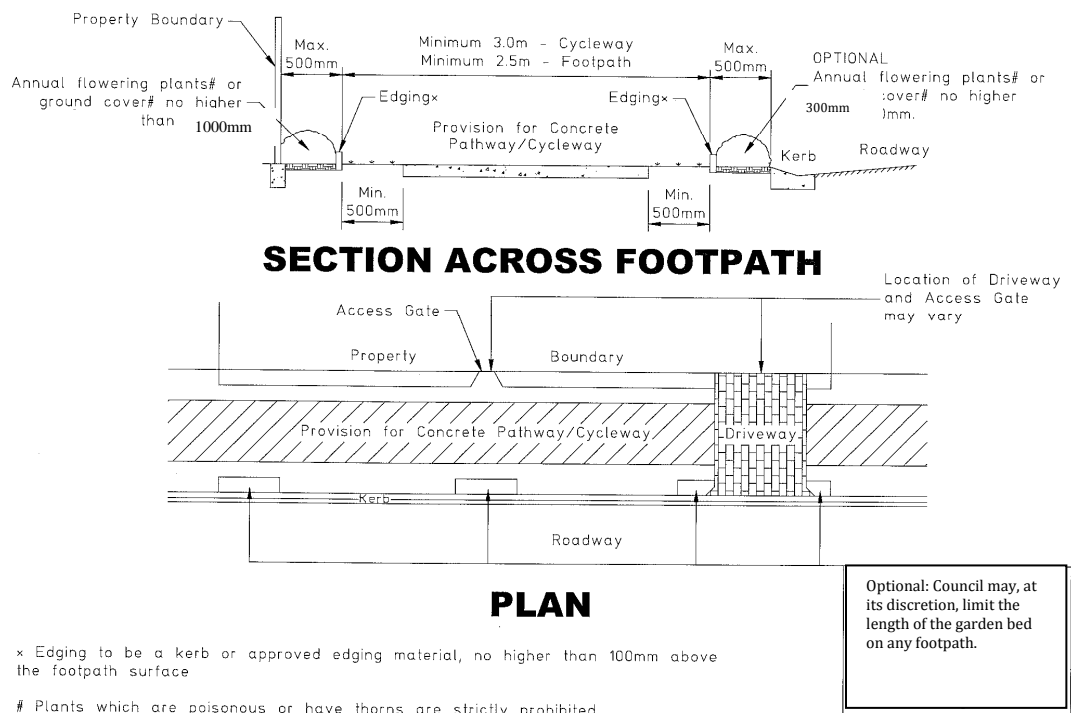

**3. Documents and materials that must accompany an application for an approval**

- (1) Full details of the proposed alteration or improvement including plans and specifications.
- (2) Details of all building work and other work to be carried out under the approval.
- (3) Details of the time and place at which the prescribed activity will be undertaken.
- (4) The proposed term of the approval.
- (5) The impact, if any, of the prescribed activity on vehicular or pedestrian traffic.
- (6) The materials, equipment and vehicles to be used in the undertaking of the prescribed activity.
- (7) Plans and specifications detailing—
  - (a) the relevant part of the local government controlled area or road that is to be used for the undertaking of the prescribed activity; and
  - (b) the proposed location of each structure and item of equipment to be used in the undertaking of the prescribed activity; and
  - (c) the type and location of any utility, service or infrastructure to be used in the undertaking of the prescribed activity.
- (8) A copy of each policy of insurance of the applicant which is applicable to the undertaking of the prescribed activity including, without limitation, a public liability insurance policy which provides indemnity for each individual occurrence in an amount not less than \$10,000,000.00.

**4. Additional criteria for the granting of an approval**

The alteration or improvement must not—

- (1) result in—
  - (a) harm to human health or safety; or
  - (b) property damage or loss of amenity; or
  - (c) nuisance; or
  - (d) obstruction of vehicular or pedestrian traffic; or
  - (e) environmental harm; or

- (f) environmental nuisance; or
- (2) adversely affect the amenity of the area in which the prescribed activity is to be undertaken.

**5. Conditions that must be imposed on an approval**

No conditions prescribed.

**6. Conditions that will ordinarily be imposed on an approval**

- (1) The conditions of an approval may—
  - (a) require compliance with specified safety requirements; and
  - (b) regulate the time within which the alteration or approval must be carried out; and
  - (c) specify standards with which the alteration or improvement must comply; and
  - (d) require the approval holder to—
    - i. carry out specified additional work such as earthwork and drainage work; and
    - ii. take out and maintain public liability insurance as specified by the local government and produce documentary evidence of the insurance to the local government before commencement of the alteration or improvement; and
    - iii. give the local government specified indemnities; and
    - iv. maintain structures erected or installed, or vegetation planted, under the approval, in good condition; and
    - v. remove a structure erected or installed, under the approval, at the end of a stated period; and
    - vi. exhibit specified signage warning about the conduct of the prescribed activity.
- (2) The conditions of an approval may require the approval holder to take specified measures to ensure that the undertaking of the prescribed activity does not cause unsafe movement or obstruction of vehicular or pedestrian traffic.

**7. Term of an approval**

- (1) The term of an approval must be determined by the local government having regard to the information submitted by the applicant.

- (2) The term of the approval must be specified in the approval.

**8. Term of renewal of an approval**

- (1) The term for which an approval may be renewed or extended must be determined by the local government having regard to the information submitted by the approval holder.
- (2) If the local government grants the application, the local government must specify in the written notice, the term of the renewal or extension.

## **Schedule 7            Commercial use of local government controlled areas and roads**

section 11

**1.    Prescribed activity**

Commercial use of local government controlled areas and roads.

**2.    Activities that do not require approval under the authorising local laws**

**3.    Nil**

**4.    Documents and materials that must accompany applications for approval**

An application for approval must be accompanied by—

- (1) a certified copy of any other registration, licence, permit or approval required for the activity under any other law; and
- (2) description of structures to be used and works or activities to be undertaken as part of the activity; and
- (3) if the activity is to operate from a vehicle—a full description of the vehicle and its registration number.

**5.    Additional criteria for the granting of approval**

For all approvals, the additional criteria are—

- (1) the physical suitability of the area or road for the proposed use; and
- (2) the likelihood of the use causing nuisance, inconvenience or annoyance to the occupiers of the adjoining land, vehicular traffic or pedestrians; and
- (3) the likely effect on the amenity of the surrounding area; and
- (4) the likely effect on the local environment and any risk of pollution or other environmental damage; and
- (5) the proximity of the activities to other existing commercial businesses; and
- (6) the appropriateness, quality and condition of equipment to be used in the activity; and
- (7) the likely impact on the ability of the general public to use the site concurrently with the proposed activity; and
- (8) the applicant's proposals regarding the provision of shade and shelter to protect against environmental conditions; and

- (9) whether the applicant's proposed waste management strategy makes provision for the satisfactory collection, storage and removal of all waste generated by the proposed activity.

## **6. Conditions that must be imposed on approvals**

A condition that must be imposed on an approval is that the approval holder must comply with the standard public liability insurance condition.<sup>4</sup>

## **7. Conditions that will ordinarily be imposed on approvals**

- (1) For all approvals, the conditions that will ordinarily be imposed on an approval are that the approval holder must—
- (a) permit access to local government staff or contractors at all times to inspect or service facilities; and
  - (b) carry out the activity in accordance with any standards of the local government applicable at the time of the approval; and
  - (c) conduct the activity only on the days and times, and at the specific locations or areas, specified in the approval; and
  - (d) display the approval in the ways stated in the approval and produce the approval for inspection on demand by an authorised person; and
  - (e) comply with measures specified in the approval to protect the safety of persons who may be involved in, or affected by, the activities authorised by the approval; and
  - (f) comply with measures specified in the approval to ensure that the activities authorised by the approval do not cause a nuisance; and
  - (g) comply with a requirement to submit the business, vehicle or premises to be inspected by an authorised person; and
  - (h) maintain a defined access point for emergency vehicles at all times; and
  - (i) if the approval authorises the approval holder to use a specified part of a local government controlled area or road for carrying on a business—
    - i. pay rental specified in the approval to the local government at specified intervals; and
    - ii. maintain the area where the activity takes place in clean, tidy and orderly condition; and
  - (j) if the activity involves playing live or taped performances—obtain a casual licence from the Australasian Performing Rights Association; and

---

<sup>4</sup> See section 4(2) of this subordinate local law.

- (k) if the activity involves use of a footpath—maintain a clear unobstructed pedestrian corridor of not less than 2 metres or, in the case of high usage footpaths, a distance greater than 2 metres stipulated in the approval; and
  - (l) seek written authorisation from an authorised person prior to playing amplified music; and
  - (m) comply with relevant workplace health and safety requirements.
- (2) For an approval for mobile food vending, the additional conditions that will ordinarily be imposed are that the approval holder must—
- (a) not sell, or offer for sale, any food within 200 metres of a retail shop selling similar items of food; and
  - (b) not, unless authorised by an authorised person, park the vehicle used for that activity for a period longer than is necessary to serve a customer who has hailed down the vehicle; and
  - (c) keep the vehicle at all times in a clean, tidy and orderly condition.
- (3) For an approval for roadside vending, the additional conditions that will ordinarily be imposed are that the approval holder must—
- (a) not sell, or offer for sale, any goods within 200 metres of a shopping centre or any retail business selling similar goods; and
  - (b) not amplify, or cause to be made, any noise identifying, advertising or otherwise drawing attention to a roadside vending stall; and
  - (c) keep the vehicle or stall and all goods contained therein or thereon, at all times in a clean, tidy and orderly condition; and
  - (d) maintain the area in which the vending activity is conducted at all times in a clean and tidy condition.
- (4) For an approval for footpath dining, additional conditions may be imposed.
- (5) For an approval for displaying goods for sale on footpaths, additional conditions may be imposed.
- (6) For an approval for a street stall, additional conditions that will ordinarily be imposed on an approval are that the approval holder must—
- (a) not sell perishable or potentially hazardous foods; and
  - (b) not manufacture, prepare or pack any food for sale at a street stall; and
  - (c) unless otherwise approved for charitable purposes, not sell or offer for sale any food, goods or other articles at a street



- stall in direct competition with any shopkeeper operating in the immediate vicinity of the stall; and
  - (d) locate the stall as close as practicable to either the shop front or the outer edge of the roadside kerb; and
  - (e) not accost passers-by to encourage the purchase of goods.
- (7) For an approval for busking, additional conditions that will ordinarily be imposed on an approval are that the approval holder must not—
- (a) cause a nuisance to the proprietors of business premises or occupiers of any residence located in close proximity to the busking activity; and
  - (b) use any amplification equipment or cause to be made any unreasonable noise during the conduct of the busking activity; and
  - (c) accost or cause a nuisance to passers-by; and
  - (d) solicit audience participation in the busking activity.

**8. The term of the approval.**

The term of the approval shall be the term stated in the approval.

**9. Term of renewal of approval.**

The term of a renewal of the approval shall be the term stated in the renewal.

## **Schedule 8            Establishment or occupation of a temporary home**

section 11

**1.        Prescribed activity**

Establishment or occupation of a temporary home.

**2.        Activities that do not require approval under the authorising local laws**

Not Applicable

**3.        Documents and materials that must accompany applications for approval**

The following documents and materials must accompany an application for approval—

- (1) a drawing showing the design and dimensions of the proposed temporary home; and
- (2) details of the materials out of which the temporary home is (or is to be) constructed and other structural details of the temporary home; and
- (3) details of the location of the temporary home; and
- (4) if the applicant is not the owner of the land on which the temporary home is (or is to be) located—the written consent of the owner; and
- (5) details of the names of the persons who are to occupy the temporary home; and
- (6) details or plans, where relevant, for—
  - (a) wastewater;
  - (b) sewerage;
  - (c) water supply;
  - (d) painting;
  - (e) engineering;
  - (f) structural approval.
- (7) any other supporting documentation and materials requested on the approved application form.

**4.        Additional criteria for the granting of approval**

The following criteria are criteria that must be considered for the granting of approval –

- (1) that –
  - (a) the temporary home is not intended to be used as a permanent or indefinite place of habitation; and,

- (b) there is a current development approval to erect a dwelling on the relevant land which dwelling (or part of which dwelling) will be used as a permanent or indefinite of habitation; and
  - i. The temporary home has in the opinion of an authorized person a sufficient source of water supply and sufficient means of disposal of effluent and refuse to ensure that minimum standards of health and hygiene for safe human habitation can be established and maintained.
  - ii. That reasonable ground exist to justify the need to establish and occupy a temporary home, including special consideration where a natural disaster or emergency situation has the existing dwelling house unsuitable for habitation.

## **5. Conditions that must be imposed on approvals**

The following conditions are conditions that must be imposed on approvals—

### **1) The approval must state—**

- (a) the date by which substantial progress must be made towards the completion of the dwelling to be constructed on the land ; and
- (b) the date by which the temporary home must be dismantled and removed; and
- (c) the construction materials and methods of construction of the temporary home or any part thereof; and
- (d) the dimensions of the temporary home or any part thereof; and
- (e) painting and other external treatment of the temporary home or any part thereof, either at the stage of construction or at any later time; and
- (f) ablution, toilet and laundry facilities which must be provided as part of the temporary home; and
- (g) the method by which water is to be supplied to the temporary home; and
- (h) the method by which waste water and refuse are to be disposed of from the temporary home.
- (i) a sign indicating premises is a temporary occupation, authorized by North Burnett Regional Council, should be erected at the main road entry to the property. Please contact the North Burnett Regional Council for sign requirements. A sign (450mm x 600mm) shall include expiry date and be erected at the main road entry to the property.

## **6. Conditions that will ordinarily be imposed on approvals**

Not applicable.

**7. Term of approval**

An approval commences on the date of issue and terminates on:

- (a) the date specified in the approval, being a date determined by the local government but being not more than 12 months after the date of issue; or
- (b) the date on which a dwelling on the relevant land is substantially completed, whichever is sooner.

**8. Term of renewal of approval**

The term of any renewal is the same term as the original approval subject to compliance with all conditions stated on the approval.

## Schedule 9 Installation of temporary advertising devices

section 11

### 1. Prescribed activity

Installation of temporary advertising devices.

### 2. Activities that do not require approval under the authorising local law

(1) An approval under the authorising local law is not required for—

- (a) a temporary advertising device that has been authorised as part of an approval for another prescribed activity under the authorising local law; or
- (b) a temporary advertising device that advertises a not for profit community event and—
  - i. is installed on a lot used for community purposes; and
  - ii. advertises activities conducted on the site; and
  - iii. is no greater than 2.00m<sup>2</sup>.
- (c) an exempt temporary advertising device.

*Example for paragraph (b)*—A separate approval is not required for installation of a sign advertising a temporary entertainment event if an approval for operation of the temporary entertainment event specifically authorises the installation of the sign.

(2) On a road, an **exempt temporary advertising device** is a temporary advertising device that complies with the following circumstances—

- (a) for all temporary advertising devices on a road—
  - i. the person displaying the device has standard public liability insurance that covers the device; and
  - ii. the device does not interfere with any underground utilities; and
  - iii. the device is non-rotating, is not illuminated and does not incorporate reflective or fluorescent materials; and
  - iv. the device does not interfere with the road or its operation; and
  - v. the device is not located on a motorway, freeway or road of a similar standard; and
  - vi. the device is located as close as practicable and parallel to the property boundary; and
  - vii. no portion of the sign projects over the carriageway or any surface used by motor vehicles; and

- viii. the device is not located in a place that is likely to distract motorists, restrict sight distances on approaches to intersections, restrict the visibility of other authorised signs, or otherwise impact on safety; and
- ix. the device is not located in a place that is likely to cause a safety hazard to other traffic (for example, pedestrians or cyclists); and
- x. the device is not fastened to trees or road infrastructure (for example, signs or guardrails); and
- xi. the device is made of a frangible material that is designed to be easily broken and the stake or frame on which the device is fastened has a cross section measurement of not more than 55mm x 25mm; and
- xii. where the speed limit is 60km/h or below, a minimum of 2 metres of unobstructed pedestrian access way is maintained at all times; and
- xiii. where the speed limit is 60 - 80km/h, the device is located at least 3.5 metres from the edge of the nearest traffic lane; and
- xiv. where the speed limit is greater than 80km/h, the sign is located at least 6 metres from the edge of the nearest traffic lane; and
- xv. the sign is not left in place in the event of extreme weather; and
- xvi. the sign does not contain explicit, inappropriate, offensive or irrelevant content; and
- xvii. All temporary advertising devices will be removed within five days following the event advertised.

(b) either—

- i. for a garage sale sign—
  - a. the sign is not one of more than 4 signs advertising the same garage sale; and
  - b. the sign is not in place earlier than the day before the commencement of the garage sale and after 24 hours of the conclusion of the sale; and
  - c. the sign is not in place for more than 72 hours for any one garage sale; and
  - d. the sign is not erected for a sale at a premises where a garage sale has been held on 4 occasions already in the previous year; or

- ii. for a temporary sign advertising a not for profit community event—
    - a. the sign is not one of more than 8 signs advertising the same event; and
    - b. the sign is not in place earlier than 2 weeks before the commencement of the event and after 24 hours of the conclusion of the event; or
  - iii. for a real estate directional sign—
    - a. the sign has a face area not exceeding 0.4 square metres; and
    - b. the sign is not one of more than 3 real estate directional signs installed for the same premises being offered for sale or auction; and
    - c. the sign is displayed only on the day when a premises is open for inspection or being auctioned; and
    - d. the sign is located so as not to cause a hazard to traffic or pedestrians or otherwise pose a risk to public safety.
- (3) On a place other than a local government controlled area or road, an **exempt temporary advertising device** is any of the following—
- (a) a portable 'A' frame or inverted 'T' frame board sign that is located within the curtilage of the principal place of business for the business being advertised on the sign;
  - (b) a real estate sign that is—
    - i. not one of more than 3 signs advertising the same site and each sign has a face area not exceeding 1.08 square metres; or
    - ii. at a site where there are no other real estate signs and it has a face area not exceeding 3.0 square metres; and
    - iii. placed only on a site being offered for sale, lease or auction; and
    - iv. in the case of an individual property—removed from a premises within 14 days of the property reaching settlement or being leased; and
    - v. in the case of a group of dwellings (for example, multiple dwellings) or building sites (for example, newly subdivided estates)—removed from the premises within 14 days of the last remaining property reaching settlement or being leased;

- (c) an election sign during an election period.
- (d) a real estate hoarding that is—
  - i. on a lot greater than 2000m<sup>2</sup>; and
  - ii. the only real estate hoarding at the site and has a sign face area not exceeding 8.0 square metres; and
  - iii. placed only on the site being offered for sale, auction or lease; and
  - iv. not erected in association with any other real estate sign; and
  - v. in the case of an individual property— removed from the premises within 14 days of the property reaching settlement or being leased; and
  - vi. in the case of a group of dwellings (for example, multiple dwellings) or building sites (for example, newly subdivided estates)—removed from the premises within 7 days of the last remaining property reaching settlement or being leased;
- (e) temporary bunting that—
  - i. is displayed for a period of not more than 7 days prior to and on the day or days of the event or promotion to which it relates; and
  - ii. is erected no higher than 6.0 metres above the original ground level of a site; and
  - iii. is not affixed to trees, lighting standards or power poles; and
  - iv. does not extend over car parking areas; and
  - v. does not cause unreasonable disturbance to the general locale;
- (f) a banner, other than a third party advertising banner, that—
  - i. is erected within, parallel to and immediately adjacent to the frontage of the premises to which it relates; and
  - ii. is limited to a size no greater than 3.8 metres x 1 metre; and
  - iii. consists of good quality materials and is sign written with appropriate wording relating; and
  - iv. if attached to banner poles—is positioned so that pedestrian and vehicle movements are not interfered with; and
  - v. is not attached to a tree; and
  - vi. has either ropes stitched in or eyelets stitched into its corners; and



- vii. is attached by stainless steel wire ropes, or ropes or nylon with a diameter of not less than 8-10 millimetres; and
  - viii. is displayed for no more than 10 weeks in any 52 week period;
- (g) a third party advertising device that is—
- i. located on residential property for the purpose of advertising activities currently conducted or directly associated with the primary use of the property; and
  - ii. no greater than 0.6m<sup>2</sup>; and
  - iii. in place only while the use referred to in subparagraph (i) is underway.
- (4) In this section—
- election period*** means— for a local government election—the period of 28 days preceding the day of the election; or
- (a) for a State government election—the meaning given in the *Electoral Act 1992*, section 3; or
  - (b) for a Commonwealth government election—the period beginning on the day after the writ for the election is issued and ending on the day of the election; or
  - (c) for another election—
    - i. the election period stipulated by the Act providing for the election; or
    - ii. if no period is stipulated by the Act—the period of 28 days preceding the day of the election; or
  - (d) for a referendum—the period beginning on the day after the writ for the referendum is issued and ending on the day of the referendum.

### 3. Documents and materials that must accompany applications for approval

*This section has been intentionally left blank.*

### 4. Additional criteria for the granting of approval

The additional criteria are that—

- (c) the proposed advertising device is structurally sound; and
- (d) the device will not obstruct or distract traffic in an unsafe manner; and
- (e) the device will not unreasonably obstruct views; and

- (f) the effect on amenity will not be detrimental; and
- (g) the device is consistent with the surrounding buildings and environment.

**5. Conditions that must be imposed on approvals**

*Not Applicable.*

**6. Conditions that will ordinarily be imposed on approvals**

- (2) For all approvals, the conditions that will ordinarily be imposed are that—
- (a) the person displaying the device has standard public liability insurance that covers the temporary advertising device; and
  - (b) the device does not interfere with any underground utilities; and
  - (c) the device does not interfere with the road or its operation; and
  - (d) the device is not located on a motorway, freeway or road of a similar standard; and
  - (e) no portion of the sign projects over the carriageway or any surface used by motor vehicles; and
  - (f) the device is not located in a place that is likely to distract motorists, restrict sight distances on approaches to intersections, restrict the visibility of other authorised signs, or otherwise impact on safety; and
  - (g) the device is not located in a place that is likely to cause a safety hazard to other traffic (for example, pedestrians or cyclists); and
  - (h) the device is not fastened to trees or road infrastructure (for example, signs or guardrails); and
  - (i) the device is made of a frangible material that is designed to be easily broken and the stake or frame on which the device is fastened has a cross section measurement of not more than 55mm x 25mm; and
  - (j) where the speed limit is 60km/h or below, a minimum of 2 metres of unobstructed pedestrian access way is maintained at all times; and
  - (k) where the speed limit is 60 - 80km/h, the device is located at least 3.5 metres from the edge of the nearest traffic lane; and
  - (l) where the speed limit is greater than 80km/h, frangible the sign is located at least 6 metres from the edge of the nearest traffic lane; and
  - (m) the sign is not left in place in the event of extreme weather; and

- (n) the sign does not contain explicit, inappropriate, offensive or irrelevant content.
- (3) For an approval for installing a portable 'A' frame or inverted 'T' frame board sign in a local government controlled area or on a road, the conditions that will ordinarily be imposed on an approval are that—
- (a) the size of the sign must be within the range of 600mm (width) x 600mm (height) to 600mm (width) x 1200mm (height); and
  - (b) the sign must be fitted with a strut or other approved mechanism to ensure the sign can not close accidentally; and
  - (c) the sign must be fixed or weighted so as to ensure stability; and
  - (d) all corners of the sign must be chamfered; and
  - (e) the maximum number of signs that may be installed for a business is—
    - iii. for corner businesses—1 sign on each street frontage; or
    - iv. for businesses within an arcade—2 signs shall be permitted at each street frontage to be utilised for the advertising of all businesses within the arcade (an arcade includes a cluster of five or more shops or offices, not less than four of which have no street frontage); or
    - v. for upstairs premises of a business that has no street frontage other than an entrance or exit which is not within an arcade—1 sign; or
    - vi. for businesses with a street frontage of more than 10 metres—1 sign for each ten metres of shop frontage up to a maximum of two signs; or
    - vii. in any other circumstances—1 sign; and
  - (f) signs must be placed at the roadside edge of the footpath and set back 0.3m from the kerb; and
  - (g) signs must be removed from the footpath during the hours when the business is closed;
  - (h) the approval holder must supply proof of standard public liability insurance to a minimum of \$10 million that covers use of 'A' or 'T' frame advertising signs and indemnifies the local government from any claims; and
  - (i) the sign must not be located within any landscaped area or garden bed.

## 7. Term of approval

The term of an approval commences on the date the approval is granted and expires on the next 30<sup>th</sup> day of June, unless otherwise specified in the approval.

**8. Term of renewal of approval**

The term of a renewal of the approval shall be the term stated in the renewal.

## Schedule 10 Keeping of animals

section 11

### 1. Prescribed activity

Keeping of animals.

### 2. Activities that do not require approval under the authorising local law

*This section has been intentionally left blank.*

### 3. Documents and materials that must accompany applications for approval

An application for approval must be accompanied by—

- (a) the species, breed, age, gender and any unique identification number of the animal or each of the animals for which the approval is sought; and
- (b) the number of animals proposed to be kept; and
- (c) the area, or part of the area, in which the animal or animals are proposed to be kept; and
- (d) the nature of the premises in which the animal or animals are proposed to be kept; and
- (e) where relevant according to the additional criteria for particular approvals in section 4, evidence of current membership of a relevant association or club; and
- (f) where relevant according to the additional criteria for particular approvals in section 4, written consent to the keeping of the animals signed by occupiers of adjoining properties where the area of the subject property is less than 6000m<sup>2</sup>.
- (g) if relevant—a copy of any development permit under the *Sustainable Planning Act 2009*; and
- (h) the prescribed fee fixed by resolution of the local government; and
- (i) in the case of dogs—an indication of whether the applicant is seeking an approval to breed the dogs; and
- (j) the name of each person who is to occupy any residence located on the premises on which the animal or animals are to be kept.

### 4. Additional criteria for the granting of approval

- (1) For all approvals, the additional criteria are that—

- (a) the land is physically suitable for the keeping of the animal; and
  - (b) the enclosure in which the animal is to be kept is structurally suitable; and
  - (c) the animal is not likely to cause undue nuisance, inconvenience, or annoyance to the occupiers of adjoining land; and
  - (d) the animal will not have a significant detrimental effect on the amenity of the surrounding area; and
  - (e) the animal will not have a significant detrimental effect on the local environment or cause pollution or other environmental damage.
- (2) For an approval to keep more than 2 dogs (except greyhounds) or 3 cats, the additional criteria are that—
- (a) written consent has been obtained from any occupiers of adjoining properties; and
  - (b) either—
    - viii. in the case of dogs—the applicant requires the dogs as working dogs for the control and management of stock on a grazing property, as defined by the Animal Management Act 2009; or
    - ix. in the case of dogs or cats—other special circumstances exist justifying the need for keeping more than 2 dogs or 3 cats; or
    - x. in the case of dogs or cats that were resident within the North Burnett Regional Council area prior to the introduction of this Local Law, and were in an area that allowed the keeping of more than two cats or dogs.
- (3) For an approval to keep more than 6 greyhounds, the additional criteria are that—
- (a) the applicant is a member of the Greyhound Racing Authority of Queensland; and
  - (b) the area of land for the keeping of the greyhounds is greater than 20,000m<sup>2</sup>; and
  - (c) written consent has been obtained from any occupiers of adjoining properties.
- (4) For an approval to keep a guard dog, the additional criteria are that—
- (a) the fencing proposed for the keeping of the dog is suitable to contain the dog at all times; and
  - (b) the applicant has demonstrated suitable measures to mitigate noise emitted by the dog; and
  - (c) a suitable person will be available to be contacted in relation to the dog at all times.

- (5) For an approval to keep pigeons or doves, the additional criteria are that—
  - (a) written consent has been obtained from any occupiers of adjoining properties; and
  - (b) if the applicant is not the owner of the land on which the animal is to be kept—written consent has been obtained from the owner of the land.
- (6) For an approval to keep a rooster, the additional criterion are that—
  - (a) written consent has been obtained from any occupiers of adjoining properties; and
  - (b) if the applicant is not the owner of the land on which the animal is to be kept—written consent has been obtained from the owner of the land; and
  - (c) the applicant produces evidence of current membership of a recognised and functioning poultry club; and
  - (d) the applicant has demonstrated suitable measures to mitigate noise emitted by the rooster.

## **5. Conditions that must be imposed on approvals**

The following conditions are conditions that must be imposed on approvals –

- (a) The approval holder must –
  - i. care for the animal in accordance with appropriate standards; and
  - ii. keep the animal in enclosures that comply with specified structural requirements; and
  - iii. comply with specified standards of hygiene; and
  - iv. ensure that the animal wears or displays an appropriate identifying tag; and
  - v. ensure that the animal does not cause nuisance, inconvenience or annoyance to others; and
  - vi. take specified action to protect against possible harm to the local environment; and
  - vii. comply with all reasonable directions of an authorised person in the time specified by the authorised person.

## **6. Conditions that will ordinarily be imposed on approvals**

The conditions that will ordinarily be imposed on an approval are that the approval holder must—

- (a) keep the animal or animals in an enclosure that complies with any structural requirements specified in the approval; and

- (b) keep the animal or animals in a manner that complies with standards of hygiene specified in the approval; and
- (c) not keep more than any maximum number of animals specified in the approval; and
- (d) except in relation to an approval for keeping pigeons or doves—not seek to use the approval to keep any animal other than the specific animal registered on the approval; and
- (e) take any action specified in the approval to protect against possible harm to the local environment.

**7. Term of approval**

The term of an approval commences on the date the approval is granted and expires on the next 30<sup>th</sup> day of June, unless otherwise specified in the approval.

**8. Term of renewal of approval**

The term of a renewal of the approval shall be the term stated in the renewal.



## Schedule 11      Operation of camping grounds

section 11

### 1.      **Prescribed activity**

Operation of camping grounds.

### 2.      **Activities that do not require approval under the authorising local law**

*This section has been intentionally left blank.*

### 3.      **Documents and materials that must accompany applications for approval**

An application for approval must be accompanied by—

- a) a plan of the camping ground showing the boundaries of the camping ground and the division of the camping ground into camping sites;
- b) if the applicant is not the owner of the land on which the camping ground is situated—the written consent of the owner to the application; and
- c) details of the facilities on the land which will be provided for use by the campers; and
- d) details of water quality, reticulation and drainage; and
- e) the proposed maximum number of occupants; and
- f) details of waste management systems; and
- g) projected average and maximum duration of stay of occupants; and,
- h) details of a cleaning and maintenance schedule that specifies the frequency with which camping ground facilities are to be cleaned and maintained.

### 4.      **Additional criteria for the granting of approval**

The additional criteria for the granting of the approval are—

- a) the suitability of the number of persons that will be camping on the land ; and
- b) whether the grant of the approval will cause or be likely to have a negative impact on the amenity of the area; and
- c) whether the facilities on the land are of an acceptable standard or can be brought to an acceptable standard for use by the intended occupants; and

- d) the environmental significance of the site and its capacity to accommodate the scale and intensity of the proposed activity.

## 5. Conditions that must be imposed on approvals

The conditions that must be imposed on an approval are that the approval holder must—

### *General*

- a) keep a register of campers and vehicles containing—
  - i. the names and addresses of each person who hires a site on the camping ground;
  - ii. an identifying number for the accommodation or site; and
  - iii. if a caravan is brought onto the site—the registration number of the caravan and (if applicable) the vehicle towing it; and
  - iv. the dates when the hiring of the site begins and ends; and
- b) maintain any buildings, facilities, fixtures, fittings, equipment and furniture provided by the approval holder on the camping ground in good working order, in a good state of repair and in a clean, tidy and hygienic condition; and
- c) ensure that all cleaning and maintenance is undertaken in accordance with the approved schedule in the approval; and
- d) not change the operation of the camping ground in any material particular (including the use of any site) without submitting an application for amendment of the current approval; and

### *Waste*

- e) provide sufficient waste containers to accommodate the collection and storage of all waste generated as part of the operation of the camping ground and such containers must be—
  - i. fitted with close fitting lids; and
  - ii. regularly serviced and maintained in a clean, tidy and hygienic condition; and
  - iii. designed and constructed to prevent access to pests and other animals; and
  - iv. designed and constructed to be easily and effectively cleaned and disinfected; and
  - v. kept closed when not in use; and
- f) ensure that all waste generated as part of the operation of the camping ground is kept so as not to attract pests and removed and disposed of in a sanitary manner; and

*Water supply*

- g) ensure that any water supply outlet for non-potable water is clearly be labelled with the words, "Unsuitable for Drinking"; and

*Pest control*

- h) ensure that the camping ground:
  - i. is kept free of pests; and
  - ii. is kept free of conditions that offer harbourage for pests;
  - iii. does not attract fly breeding

**6. Conditions that will ordinarily be imposed on approvals**

The conditions that will ordinarily be imposed on an approval are that the approval holder must—

*General*

- a) limit the number of persons occupying a camping site to any number specified in the approval; and
- b) limit the period of the stay to a maximum 14 days; and
- c) ensure that campers comply with the conditions of their camping permit; and
- d) clearly display site numbers for each site in accordance with the approved plan of the camping ground; and
- e) maintain site sizes and locations in accordance with the approved plan of the camping ground; and
- f) ensure that persons do not camp or sleep in a place within the camping ground that is not a site nominated in the approved plan of the camping ground; and

*Toilets and ablution facilities*

- g) provide satisfactory amenities to cater for the occupants of the camping ground; and

*Water supply*

- h) maintain an adequate supply of water to all toilet, bathroom, laundry and drinking water facilities that form part of the camping ground; and
- i) maintain an adequate supply of hot water to all bathroom and laundry facilities that form part of the operation of the camping ground; and
- j) ensure that the water supply for drinking and ablutionary purposes is potable water; and

- k) notify the local government of any modification to the water supply system (for example, installation of a tank for the supply of water).

**7. Term of approval**

The term of an approval commences on the date the approval is granted and expires on the next 30<sup>th</sup> day of June, unless otherwise specified in the approval.

**8. Term of renewal of approval**

The term of a renewal of the approval shall be the term stated in the renewal.

## **Schedule 12 Operation of cane railways**

section 11

*This schedule has been intentionally left blank.*

## Schedule 13      Operation of caravan parks

section 11

### 1.      **Prescribed activity**

Operation of caravan parks.

### 2.      **Activities that do not require approval under the authorising local law**

*This section has been intentionally left blank.*

### 3.      **Documents and materials that must accompany applications for approval**

An application for approval must be accompanied by—

- (a) if the applicant is not the owner of the land on which the caravan park is located—the written consent of the owner; and
- (b) a site plan drawn at a scale of 1:200 showing—
  - i. the immediate area of the proposed caravan park; and
  - ii. the location within the local government area; and
  - iii. the sites for the parking of caravans; and
  - iv. the locations of the roads, buildings and structures situated on the caravan park; and
  - v. the position of all water points; and
  - vi. the position of all refuse containers; and
  - vii. the position of all sanitary, ablution and laundry buildings; and
  - viii. the position of all effluent and sullage water drainage lines and final disposal area or areas; and
  - ix. the nature and position of fire fighting facilities; and
- (c) details of the proposed administration and management of the caravan park; and
- (d) the name, address and contact details of the proposed resident manager of the caravan park; and
- (e) the maximum number of persons who can be accommodated in the caravan park.

### 4.      **Additional criteria for the granting of approval**

The additional criteria for the granting of an approval are that—

- (a) the proposed resident manager is a suitable person to be manager of a caravan park; and

- (b) the caravan park can be operated in a way which will not cause a nuisance, inconvenience or annoyance to the occupiers of adjoining land; and
- (c) all facilities in the caravan park are of an acceptable standard or can be brought to an acceptable standard for use by residents.

## 5. Conditions that will ordinarily be imposed on approvals

The conditions that will ordinarily be imposed on an approval are that the approval holder must—

- (a) ensure that—
  - i. the caravan park is managed and supervised by an individual (the resident manager) who is resident on or near the caravan park; or
  - ii. if there is temporarily no nominated resident manager of a caravan park—the approval holder takes reasonable steps to ensure that an individual who is a suitable person to act as resident manager is present at the caravan park at all reasonable times to ensure proper operation of the park; and
- b) ensure that the person responsible for management of the caravan park can be contacted at all times in case of an emergency; and
- c) ensure that the resident manager and private owners of rented caravans have access to a copy of the *Residential Tenancies and Rooming Accommodation Act 2008*, the *Manufactured Homes (Residential Parks) Act 2003*, and sections 592-595 of the *Police Powers and Responsibilities Act 2000*; and
- d) comply with limits in the approval on the number of persons permitted to be accommodated on a site; and
- e) maintain buffer zones between accommodation sites and roads, external boundaries, or facilities on the caravan park; and
- f) provide and maintain an adequate supply of water to the caravan park, including potable water for cooking and personal hygiene; and
- g) ensure that potable water is at all times protected from contamination; and
- h) ensure that, if water obtained from a particular water outlet in park may be unsuitable for drinking, a sign is prominently displayed at the outlet stating “Unsuitable for Drinking”; and
- i) maintain toilets and bathing or showering facilities for persons of both sexes (including disabled persons) using the caravan park and in accordance with the requirements in Table 1, provided that—

- i. a cabin which is fitted with a sanitary convenience shall be deemed not to be a site for the purpose of Table 1; and
- ii. an approval holder may provide sanitary conveniences in addition to those required by Table 1; and

**Table 1**

<i>No. of sites</i>	<i>No. of water closets or pan cabinets and pans for females</i>	<i>No. of water closets or pan cabinets and pans for males</i>	<i>Length of urinals for males</i>
Up to 40	1 for every 7 sites or part thereof	1 for every 10 sites or part thereof	0.6 metres for every 20 sites or part thereof
Over 40	6 plus an additional 1 for every 15 sites or part thereof in excess of 40 sites	4 plus an additional 1 for every 15 sites or part thereof in excess of 40 sites	0.6 metres for every 20 sites or part thereof

- j) cause all sanitary conveniences to be constructed so as to ensure privacy; and
- k) provide for the exclusive use of the occupants thereof separate ablutionary facilities for each sex in the ratio of one shower or bath and one hand basin to every 15 sites or part thereof, provided that a cabin which is fitted with ablutionary facilities shall be deemed not to be a site; and
- l) cause such shower or bath to be installed in a separate compartment or cubicle which is constructed so as to ensure privacy; and
- m) cause hot and cold water to be reticulated to every shower, bath and hand basin; and
- n) provide for the exclusive use of the occupants thereof laundry facilities in the ratio of one set of twin wash tubs and one clothes washing machine and one clothes hoist or an equivalent length of clothes line for every 20 sites or part thereof, provided that a cabin which is fitted with a set of twin wash tubs and a clothes washing machine shall be deemed not to be a site for the purpose of calculating the number of those items required to be provided;
- o) provide sewerage or a drainage system in conformity with the requirements of the local government for the carrying off and disposal of all wastes from every water closet fixture, urinal, ablutionary facility, laundry facility and site; and
- p) provide, at a distance not more than 10 metres (or 20 metres where a camp kitchen is provided) from any site, a waste water disposal point which is—
  - i. provided with a water stand pipe; and



- ii. provided with an impervious paved area measuring not less than 1 metre x 1 metre and graded to a central drainage inlet which is connected to sewerage or a drainage system; and
- q) maintain laundry facilities; and
- r) provide and maintain recreational facilities; and
- s) provide, in accordance with the requirements specified the approval, facilities for disposal of wastes; and
- t) maintain sewerage, drainage, refuse collection, electricity supply, telephone and postal services for the benefit of residents generally or a particular class of residents; and
- u) provide lighting of the caravan park to specified standards during specified hours; and
- v) ensure, where bedding is provided, that—
  - i. the bedding is kept in a clean and sanitary condition free of vermin; and
  - ii. if bed linen is provided—the bed linen is changed and replaced with clean bed linen whenever there is a change of occupation; and
- w) ensure that a register is kept containing—
  - i. the names and addresses of each person who hires complementary accommodation or a site on the caravan park; and
  - ii. an identifying number for the accommodation or site; and
  - iii. if a caravan is brought onto the site—the registration number of the caravan and (if applicable) the vehicle towing it; and
  - iv. the dates when the hiring of the accommodation or site begins and ends; and
- x) produce the register for inspection at the request of an authorised person; and
- y) not hire out a part of the caravan park for separate occupation unless it is a site approved by the local government for separate occupation; and
- z) not permit occupation of a site by more persons than the limit for the relevant site specified in the approval; and
- aa) not permit occupation of a caravan or other type of temporary or permanent accommodation on the caravan park by more persons than the number for which the caravan or other accommodation was designed; and

- bb) not permit a person to bring onto a site a caravan or other type of accommodation that is not fit for human habitation (for example, a caravan that is not weatherproof); and
- cc) maintain all buildings, structures and facilities on the caravan park in good and serviceable condition; and
- dd) keep the caravan park (including all sites on the caravan park) clean and tidy; and
- ee) maintain all buildings, playground areas and equipment used for recreation purposes in a safe and proper condition; and
- ff) not, unless the local government agrees in writing, change the sites in a caravan park by—
  - i. adding to the existing sites; or
  - ii. changing the position or boundaries of a site; and
- gg) not change structures or facilities in a caravan park, unless authorised by a development approval, by—
  - i. adding new structures or facilities; or
  - ii. removing existing structures or facilities; or
  - iii. changing the position of structures or facilities in the caravan park; and
- hh) impose and enforce the following conditions of use on each resident or other person who uses the caravan park—
  - i. a resident must keep accommodation occupied in a caravan park in a sanitary, clean and tidy condition; and
  - ii. if a resident brings a caravan or another type of accommodation onto a site, the resident must—
    - A. keep the accommodation in good repair; and
    - B. comply with requirements of the approval holder or an authorised person for securing the accommodation; and
  - iii. a resident must not dispose of liquid wastes on a caravan park unless the wastes are disposed of at drainage points provided for the purpose; and
  - iv. a resident must not dispose of refuse on a caravan park unless the refuse is placed in containers provided for the purpose; and
  - v. a person must not use facilities on a caravan park in a way that makes them unclean or insanitary; and
  - vi. a person who occupies a site on a caravan park must not allow onto the site more persons than the limit fixed under approval and as advised by the resident manager; and

- vii. a person who occupies a caravan or other type of temporary or permanent accommodation must not permit occupation by more persons than the number for which the caravan or other accommodation was designed.

In this section—

**bedding** includes mattresses, pillows, bed linen, blankets and bed coverings; and

**cabin** means an unregistered movable dwelling that is provided for hire, complying with the requirements of the *Building Act 1975* for the appropriate class of residential building; and

**complementary accommodation** means the other accommodation that is prescribed as appropriate to caravan parks is accommodation is –

- on-site caravan; and,
- a cabin; and,
- a manufactured home; and,
- a tent or other structure that can be readily assembled and disassembled.

**resident** means a person who resides on a caravan park site, on a temporary or permanent basis; and

**site** means a part of a caravan park for parking a caravan or for complementary accommodation.

## 9. Term of approval

The term of an approval commences on the date the approval is granted and expires on the next 30<sup>th</sup> day of June, unless otherwise specified in the approval.

## 10. Term of renewal of approval

The term of a renewal of the approval shall be the term stated in the renewal.

## Schedule 14      Operation of cemeteries

section 11

### 1.      Prescribed activity

Operation of cemeteries.<sup>5</sup>

### 2.      Activities that do not require an approval under the authorising local law

No activities stated.

### 3.      Documents and materials that must accompany an application for an approval

(1) Details of the proposed cemetery including—

- (a) a site plan, drawn to scale; and
- (b) the proposed number of grave sites; and
- (c) the depth of each proposed grave site; and
- (d) the number of bodies to be buried in each proposed grave site; and
- (e) reinterment arrangements for each proposed grave site; and
- (f) the proposed hours of operation.

(2) Details of the proposed administration and management of the proposed cemetery.

(3) If a development approval for the cemetery is required under the *Sustainable Planning Act 2009* — a copy of the development approval.

(4) If the application for an approval does not relate to a local government cemetery and the applicant is not the owner of the premises on which the prescribed activity is to be undertaken — the written consent of the owner of the premises.

---

<sup>5</sup> See *Local Law No. 1 (Administration) 2011*, schedule 2, part 2, *operation of cemeteries* means to operate a place for disposing of human remains by—

- (a) burial; or
- (b) cremation; or
- (c) placement in a columbarium, mausoleum or vault.

#### **4. Additional criteria for the granting of an approval**

- (1) The operation of the prescribed activity must not result in—
  - (a) harm to—
    - i. human health; or
    - ii. safety; or
    - iii. any watercourse or underground water system; or
  - (b) personal injury; or
  - (c) a loss of amenity; or
  - (d) a nuisance.
- (2) The proposed administration and management of the cemetery, and in particular, the proposed record keeping system, must be appropriate.

#### **5. Conditions that must be imposed on an approval**

- (1) The approval holder must—
  - (a) keep the cemetery open to the public during particular hours as specified by the local government; and
  - (b) ensure that an appropriate identifying plaque is placed on or adjacent to the place of each disposal until an appropriate memorial to the deceased is erected or installed.
- (2) A burial, cremation or other disposal at the cemetery must not be carried out outside the hours during which the cemetery is open to the public.
- (3) A person must not reopen a grave, or exhume a body or the remains of a body buried in the cemetery other than—
  - (a) under the authority of an approval under the *Coroner's Act 2003* and on the production of the approval; and
  - (b) with the approval of the local government (under the subordinate local law regulating activities regarding human remains, if applicable).
- (4) All remains in the cemetery must be enclosed in a coffin, or another form of container, or a shroud, appropriate to the form of disposal.

#### **6. Conditions that will ordinarily be imposed on an approval**

- (1) The approval holder must take specified measures to—

- (a) prevent harm to the health and safety of persons who may be involved in, or affected by, the undertaking of the prescribed activity; and
  - (b) prevent personal injury, property damage or a loss of amenity resulting from the undertaking of the prescribed activity.
- (2) The approval holder must—
- (a) take out and maintain specified insurance indemnifying a person who may suffer personal injury, loss or damage as a result of the undertaking of the prescribed activity; and
  - (b) give the local government specified indemnities.
- (3) The local government may regulate—
- (a) the position of grave sites; and
  - (b) periods of leases for grave sites; and
  - (c) requirements for the proper maintenance of memorials and other buildings and structures in the cemetery; and
  - (d) the hours when the cemetery may be open to the public; and
  - (e) the hours when a burial, cremation or disposal may take place in the cemetery; and
  - (f) standards for —
    - i. the minimum depth, size and other dimensions of graves and grave sites; and
    - ii. the size of niches; and
  - (g) standards for —
    - i. coffins; and
    - ii. shrouds; and
    - iii. other receptacles for cremated remains; and
  - (h) the number of bodies which, may be buried in a single grave; and
  - (i) the frequency with which, and the period within which, bodies may be buried in a single grave; and
  - (j) the keeping of burial records and associated maps; and
  - (k) when a grave may be reopened; and

- (l) the layout of the cemetery including, for example, the location of internal roads within the cemetery; and
- (m) the manner in which—
  - i. graves are dug; and
  - ii. grave sites are maintained.

**7. Term of an approval**

- (1) The term of an approval must be determined by the local government having regard to the information submitted by the applicant.
- (2) The term of the approval must be specified in the approval.
- (3) An approval may be granted for a term of up to 1 year.

**8. Term of renewal of an approval**

- (1) The term for which an approval may be renewed or extended must be determined by the local government having regard to the information submitted by the approval holder.
- (2) The term for which an approval may be renewed or extended must not exceed 1 year.
- (3) If the local government grants the application, the local government must specify in the written notice, the term of the renewal or extension.

## Schedule 15      Operation of public swimming pools

section 11

### 1.      **Prescribed activity**

Operation of public swimming pools.<sup>6</sup>

### 2.      **Activities that do not require an approval under the authorising local law**

(1) Section 6(2) of the authorising local law does not apply if—

(a) the public swimming pool is—

- i. on a local government controlled area; or
- ii. a State school swimming pool; or

iii. a swimming pool made available by a body corporate of a community titles scheme for use by the owners or occupiers of the lots of the scheme or their invitees; or

(b) the undertaking of the prescribed activity complies with the minimum standards prescribed in subsection (2).

### 3.      **Documents and materials that must accompany an application for an approval**

Details of the proposed public swimming pool including a plan or other information identifying the proposed public swimming pool and all buildings proposed to be used in the operation of the public swimming pool.

- (1) Details of the nature and extent of the public use that is proposed by the applicant.
- (2) Details of the proposed management and supervision of the public swimming pool (including the qualifications and experience of the proposed managers and supervisors).
- (3) If the applicant is not the owner of the land on which the public swimming pool is to be situated — the owner's written consent to the application.

---

<sup>6</sup> See Local Law No. 1 (Administration) 2011, schedule 2, part 2, **operation of public swimming pools** means the operation of a swimming pool that is made available for use to—

- (a) members of the public or a section of the public; or
- (b) participants in organised swimming or diving competitions or in training for organised swimming or diving competitions; or
- (c) persons who have a commercial relationship with the owner of the pool.



- (4) Details of the equipment that will be used for chlorination, filtration and recirculation of water in the public swimming pool.
- (5) Details of procedures that will be adopted to ensure that the public swimming pool water is adequate to protect public health.
- (6) Details of the equipment which will be used for emergency medical treatment and first aid.
- (7) Details of the operation of the public swimming pool including —
  - (a) the hours of operation of the public swimming pool; and
  - (b) whether the public swimming pool is to be heated or non-heated; and
  - (c) the existence or otherwise of automatic dosing equipment to be used in conjunction with the chlorination, filtration and recirculation of water in the public swimming pool.
- (8) A pool management plan which details proposed arrangements for each of the following—
  - (a) risk assessment; and
  - (b) monitoring, including water testing frequency; and
  - (c) emergency equipment and procedures; and
  - (d) maintenance; and
  - (e) record keeping.

**4. Additional criteria for the granting of an approval**

- (1) The equipment for chlorination, filtration and recirculation of public swimming pool water must be adequate to protect public health.
- (2) The management and supervision of the public swimming pool must be adequate to protect public safety and prevent nuisance.
- (3) Any proposed manager or supervisor of the public swimming pool must be suitably qualified.
- (4) The equipment which will be used for emergency medical treatment and first aid must be situated at an appropriate location at the public swimming pool.
- (5) Provision must be made at the public swimming pool for separate dressing rooms for male and female users of the pool that are—
  - (a) of a size sufficient to accommodate the likely maximum

number of users (at any 1 time) of the pool; and

- (b) situated and constructed so that they totally conceal persons within the dressings rooms from persons who may be outside the dressing rooms.
- (6) Provision must be made at the public swimming pool for proper and sufficient male and female sanitary conveniences.

## **5. Conditions that must be imposed on an approval**

- (1) The operation of the public swimming pool must comply with the following minimum standards—
- (a) water in the public swimming pool must at all times comply with the chemical parameters in subsections (3), table A and the microbiological criteria specified in subsection (3), table B; and
  - (b) an animal, other than a guide dog or assistance animal, must not be allowed to enter, or remain in, the enclosed area of premises on which the public swimming pool is situated; and
  - (c) the public swimming pool must be provided with all necessary equipment for—
    - i. emergency medical treatment and first aid; and
    - ii. the rescue of persons in difficulty; and
    - iii. other aspects of public health and safety; and
  - (d) the public swimming pool must be provided with a resuscitation sign and a health information notice, and the sign and notice must be exhibited as part of the operation of the public swimming pool; and
  - (e) facilities provided at the public swimming pool, such as toilets and change rooms, must be maintained in a clean and sanitary condition at all times; and
  - (f) facilities, fittings and equipment provided at the public swimming pool must be maintained in a good state of repair and working order and condition; and
  - (g) the operator of the public swimming pool must—
    - i. keep and maintain, for a minimum period of 24 months, and have available for inspection at all times at the public swimming pool—
      - A. written results of all testing of water in the public swimming pool; and
      - B. written particulars of all backwashing, chemical

- adjustments and dose settings undertaken by the operator in relation to the water in the public swimming pool at any time; and
- ii. install and maintain all necessary equipment for the disinfection, filtration and recirculation of water in the public swimming pool; and
  - iii. provide and maintain dressing rooms and facilities for showering and sanitation; and
  - iv. display, in prominent positions around the public swimming pool, 1 or more notices stipulating that children using the public swimming pool must be accompanied by an adult; and
  - v. not permit or allow any person under the influence of an intoxicating or stupefying substance or liquor to be at, or use, the public swimming pool; and
  - vi. not permit or allow any person suffering, or appearing to suffer from, an infectious, contagious or offensive disease or skin complaint, to enter the public swimming pool; and
  - vii. ensure that the public swimming pool is fitted with —
    - A. a filtration unit which is capable of giving at least 6 complete changes of water in 24 hours at the time of maximum head loss; and
    - B. a disinfection unit approved by an authorised person; and
  - viii. ensure that the public swimming pool is provided with recirculation outlets which comply with the following specifications —
    - A. the recirculation outlet must be provided at the lowest point of the public swimming pool; and
    - B. the line from the recirculation outlet must be sized as a suction line; and
    - C. if the depth of water in the public swimming pool is not uniform, multiple outlets must be provided where the width of the pool is more than 9m; and
    - D. each outlet must be spaced not more than 9m apart, nor more than 4.5m from the side walls, at the deepest part of the public swimming pool; and
    - E. recirculation outlets must be placed so as to allow for complete circulation of water to prevent short

circuiting and dead spots in the public swimming pool; and

- ix. ensure that the public swimming pool is provided with recirculation inlets which comply with the following specifications—
  - A. recirculation inlets must be sized and spaced to produce uniform circulation of the incoming water throughout the public swimming pool; and
  - B. the public swimming pool must be provided with at least 1 inlet for each 32m<sup>2</sup> of swimming pool water surface or fraction thereof; and
  - C. the entire recirculation inlet piping system must be of such size that the velocities do not exceed 3m per second using the design flow; and
  - D. suction lines must not exceed 1.5m per second using the design flow during the filtration period; and
  - E. recirculation inlets must be placed so as to allow for complete circulation of water to prevent short circuiting and dead spots in the public swimming pool; and
- x. ensure that the public swimming pool is provided with a hair and lint strainer which complies with the following specifications—
  - A. the strainer must be of a type specifically made for the removal of hair and lint and must be placed in the suction line ahead of the pump; and
  - B. the strainer must have a screen which is easily removable and have a free area not less than 5 times the cross sectional area of the suction line; and
- xi. provide and maintain—
  - A. scum gutters of an open design to permit easy cleaning of the public swimming pool; or
  - B. surface skimmers capable of removing all extraneous floating matter from the public swimming pool which comply with the following specifications—
    - (AA) the minimum width of the skimmer must be

- 25mm for every 9.3m<sup>2</sup> of surface area or fraction thereof; and
- (AB) the minimum width of the skimmer must be 75mm for any public swimming pool with a surface area of under 23.25m<sup>2</sup>; and
- (AC) 1 surface skimmer must be provided for each 46.5m<sup>2</sup> of surface area or fraction thereof; and
- C. all necessary sanitary conveniences and sanitary facilities for the operation of the public swimming pool; and
- D. all necessary waste containers sufficient to accommodate the collection and storage of waste generated by the operation of the public swimming pool in the manner, and at the locations, specified by the local government; and
- xii. at all times maintain the public swimming pool free of extraneous matter; and
- xiii. test the water in the public swimming pool to ensure compliance with the prescribed chemical parameters and microbiological criteria—
  - A. at least daily; and
  - B. more often than daily if necessary having regard to—
    - (AA) bather load and likely use; and
    - (AB) level of environmental contamination; and
    - (AC) climatic considerations; and
    - (AD) health status of pool users; and
- (h) the operation of the public swimming pool, including each building, structure, facility and equipment used in the operation of the public swimming pool must be kept and maintained—
  - i. in good working order and condition; and
  - ii. in a clean, tidy and sanitary condition; and
- (i) each toilet, bathroom, kitchen, laundry and drinking water facility used in the operation of the public swimming pool must be provided with an adequate and continuous supply of water.

- (2) This subsection (3) specifies prescribed chemical parameters and microbiological criteria for public swimming pool water.

TABLE A - CHEMICAL PARAMETERS TABLE

	Indoor Pool	Indoor Pool (Heated)	Outdoor Pool	Outdoor Pool (Heated)	Spa
Water Temperature		26°C	26°C		35°C- 37°C Ideal 40°C Max
Free Chlorine (mg/L, ppm) minimum	1.5	2	1.5	3	3
Free Chlorine (mg/L, ppm) with cyanuric acid	N/A	N/A	3	4	N/A
Total Chlorine (mg/L, ppm)	Free chlorine + 1 (10 max)	Free chlorine + 1 (10 max)	Free chlorine + 1 (10 max)	Free chlorine + 1 (10 max)	10.0
Bromine (mg/L, ppm)	3.0	4.0	3.0	4.0	4 - 6
Ozone (for Chlorine Level see above)	0 residual	0 residual	0 residual	0 residual	0 residual
pH	7.2 – 7.8	7.2 – 7.8	7.2 – 7.8	7.2 – 7.8	7.2 – 7.8
Total Alkalinity (mg/L, ppm)	80 - 200	80 - 200	80 - 200	80 - 200	80 - 200
Cyanuric Acid	0*	0*	30 – 50	30 – 50	0*

\*As indoor pools are protected from direct sunlight, cyanuric acid must not be used as the effectiveness of chlorine is reduced.

NOTE: Combined chlorine must not exceed half the total chlorine concentration with a maximum of 1.0 ppm.

TABLE B - MICROBIOLOGICAL CRITERIA TABLE

Type of Organism	Maximum Count Allowable
Heterotrophic Plate Count	100 Colony forming Units (CFU) per ml
Thermotolerant coliforms or E. Coli	Nil per 100mL
Pseudomonas aeruginosa	Nil per 100mL

## 6. Conditions that will ordinarily be imposed on an approval

- (1) The operator of the public swimming pool must test the water in the public swimming pool to ensure compliance with the prescribed chemical parameters and microbiological criteria—
- at least daily; and
  - more often than daily if necessary having regard to—

- i. bather load and likely use; and
- ii. level of environmental contamination; and
- iii. climatic considerations; and
- iv. health status of pool users.

(2) The approval holder must—

- a) provide and maintain specified equipment for emergency medical treatment, first aid and the rescue of persons in difficulty; and
- b) erect and display specified notices at the public swimming pool that—
  - i. provide information about basic life saving, resuscitation and first aid techniques; and
  - ii. warn about possible dangers; and
- c) install and maintain specified equipment for the chlorination, filtration and recirculation of water in the public swimming pool; and
- d) provide and maintain specified dressing rooms and facilities for showering and sanitation; and
- e) maintain, for inspection by an authorised person of the local government on request, a daily record or register of—
  - i. the number of persons who use the public swimming pool; and
  - ii. the daily testing of the swimming pool water to ensure compliance with prescribed chemical parameters and microbiological criteria; and
- f) display, in prominent positions around the public swimming pool, 1 or more specified notices stipulating that children using the public swimming pool must be accompanied by an adult; and
- g) not permit or allow any person under the influence of an intoxicating or stupefying substance or liquor to be at, or use, the public swimming pool; and
- h) not permit or allow any person suffering, or appearing to suffer from, an infectious, contagious or offensive disease or skin complaint to enter the public swimming pool; and

- i) not permit or allow any animal to be brought onto any part of the land upon which the public swimming pool is located; and
- j) immediately remove any animal found on any part of the land upon which the public swimming pool is located; and
- k) unless otherwise authorised by an authorised person, ensure that the public swimming pool is fitted with —
  - i. a filtration unit which is capable of giving at least 6 complete changes of water in 24 hours at the time of maximum head loss; and
  - ii. a chlorination unit approved by an authorised person; and
- l) ensure that the public swimming pool is provided with recirculation outlets which comply with the following specifications —
  - i. the recirculation outlet must be provided at the lowest point of the public swimming pool; and
  - ii. the line from the recirculation outlet must be sized as a suction line; and
  - iii. if the depth of water in the public swimming pool is not uniform, multiple outlets must be provided where the width of the pool is more than 9m; and
  - iv. each outlet must be spaced not more than 9m apart nor more than 4.5m from the side walls at the deepest part of the public swimming pool; and
  - v. recirculation outlets must be placed so as to allow for complete circulation of water to prevent short circuiting and dead spots in the public swimming pool; and
- m) ensure that the public swimming pool is provided with recirculation inlets which comply with the following specifications—
  - i. recirculation inlets must be sized and spaced to produce uniform circulation of the incoming water throughout the public swimming pool; and
  - ii. the public swimming pool must be provided with at least 1 inlet for each 32m<sup>2</sup> of swimming pool water surface or fraction thereof; and
  - iii. the entire recirculation inlet piping system must be of such size that the velocities do not exceed 3m per second using the design flow; and



- iv. suction lines must not exceed 1.5m per second using the design flow during the filtration period; and
  - v. recirculation inlets must be placed so as to allow for complete circulation of water to prevent short circuiting and dead spots in the public swimming pool; and
  - n) ensure that the public swimming pool is provided with a hair and lint strainer which complies with the following specifications—
    - i. the strainer must be of a type specifically made for the removal of hair and lint and must be placed in the suction line ahead of the pump; and
    - ii. the strainer must have a screen which is easily removable and have a free area not less than 5 times the cross sectional area of the suction line; and
  - o) if the approval holder provides alternate chemicals or substances which are approved by an authorised person and maintains disinfection of swimming pool water to a standard not less than that specified in paragraph (o), an authorised person may dispense with the requirement for the provision of a free residual chlorine content; and
  - p) provide and maintain—
    - i. scum gutters of an open design to permit easy cleaning of the public swimming pool; or
    - ii. surface skimmers capable of removing all extraneous floating matter from the public swimming pool which comply with the following specifications—
      - (A) the minimum width of the skimmer must be 25mm for every 9.3m<sup>2</sup> of surface area or fraction thereof; and
      - (B) the minimum width of the skimmer must be 75mm for any public swimming pool with a surface area of under 23.25m<sup>2</sup>; and
      - (C) 1 surface skimmer must be provided for each 46.5m<sup>2</sup> of surface area or fraction thereof; and
  - q) at all times maintain the public swimming pool free of extraneous matter.
- (3) The approval holder and each employee and agent of the approval holder who is involved in the operation of the public swimming pool, or engaged in an aquatic activity at the public swimming pool, must hold a current first aid certificate, bronze medallion or other life saving

qualifications specified in the approval.

- (4) The operation of the public swimming pool, including each building, structure, facility and equipment used in the operation of the public swimming pool must be kept and maintained—
  - (a) in good working order and condition; and,
  - (b) in a clean, tidy and sanitary condition.
- (5) Each toilet, bathroom, kitchen, laundry and drinking water facility used in the operation of the public swimming pool must be provided with an adequate and continuous supply of water.
- (6) The approval holder must provide and maintain—
  - (a) specified sanitary conveniences and sanitary facilities for the operation of the public swimming pool; and
  - (b) waste containers sufficient to accommodate the collection and storage of waste generated by the operation of the public swimming pool in the manner, and at the locations, specified by the local government.

**7. Term of an approval**

- (1) The term of an approval must be determined by the local government having regard to the information submitted by the applicant.
- (2) The term of the approval must be specified in the approval.
- (3) An approval may be granted for a term of up to 1 year.

**8. Term of renewal of an approval**

- (1) The term for which an approval may be renewed or extended must be determined by the local government having regard to the information submitted by the approval holder.
- (2) The term for which an approval may be renewed or extended must not exceed 1 year.
- (3) If the local government grants the application, the local government must specify in the written notice, the term of the renewal or extension.

## **Schedule 16      Operation of shared facility accommodation**

section 11

### **1.      Prescribed activity**

Operation of shared facility accommodation.

### **2.      Activities that do not require an approval under the authorising local law**

An approval under the authorising local law is not required for—

- (a) houses where accommodation is provided in accordance with a residential tenancy agreement under the *Residential Tenancies and Rooming Accommodation Act 2008*, ; and
- (b) accommodation for family members in exchange for a board payment; and *Examples for paragraph (b)*—Teenage or young adult children paying board to parents or aged parents living with and paying board to their adult.
- (c) accommodation at premises where professional health or welfare services are provided. *Example for paragraph (c)*—Hospitals, nursing homes, convalescent homes, retirement homes and other institutions providing treatment for persons with a disability.

### **3.      Documents and materials that must accompany applications for approval**

An application for approval must be accompanied by—

- (a) details of the facilities that are to be shared by persons for whom accommodation is provided; and
- (b) a site plan of the allotment upon which the rental accommodation premises is located; and
- (c) where applicable, the most recent building work carried out in respect of the premises for which approval was obtained under the *Building Act 1975*; and
- (d) a recent Certificate of Classification issued under the *Building Act 1975*; and
- (e) a statement as to the number of sleeping rooms in the premises, information to identify which rooms are the sleeping rooms and the number of beds in each sleeping room; and

- (f) a statement that, to the best of the applicant's knowledge after having undertaken reasonable inquiries and investigations, the premises are structurally sound and in a state of good repair; and
- (g) details of when the premises were last treated for vermin and insect pests; and
- (h) a plan of the premises; and
- (i) if the applicant is not the owner of the premises for which the approval is sought—the written consent of the owner in respect of the application.
- (j) any development approval required under the *Sustainable Planning Act 2009*; and,
- (k) any other supporting documentation and materials requested on the approved application form.

#### **4. Additional criteria for the granting of approval**

The following criteria are criteria that must be considered for the granting of approval—

- (a) whether the approval includes a pest management plan, incorporating the—
  - i. prevention of introduction of pests; and
  - ii. maintenance required to prevent harbourage of pests; and
  - iii. procedures to monitor the detection of the presence of pests; and
  - iv. intervention strategies when pests are detected; and
  - v. record keeping pertaining to the plan; and
- (b) whether the premises will be suitable and convenient for operation as accommodation premises and will provide a proper standard of hygiene, safety and comfort in the opinion of an authorised person.

#### **5. Conditions that must be imposed on approvals**

The following conditions are conditions that must be imposed on approvals—

- (a) the approval holder and operator must—
  - i. ensure that the accommodation premises is kept in a clean and sanitary condition to the satisfaction of an authorised person; and
  - ii. ensure that the accommodation premises is maintained in a good state of repair and working order to the satisfaction of an authorised person; and
  - iii. ensure that all fixtures, equipment, fittings and furniture is kept in a good state of repair and working order to the

- satisfaction of an authorised person; and
- iv. reside, or delegate an approved representative to reside, on the land at all times; and
    - A. keep a register which includes the following details—
    - B. the name and address of each occupant; and
    - C. the date of each occupant's arrival at and departure from the accommodation premises; and
  - v. the number of the bedroom and bed allocated to each occupants; and
  - vi. keep a record of all fire safety management plans, and
  - vii. keep a record of pest control, and
  - viii. keep appropriate records for any swimming pool as required by and to the satisfaction of an authorised person; and
  - ix. keep an up-to-date site plan that identifies all rooms, bed allocation and communal facilities; and
  - x. ensure that all records and site plans are maintained and made available for perusal by an authorised person on request, and kept at the office at all times while the office is open in a fireproof safe located at the accommodation premises when the office is not open and saved and backed up electronically off site; and
  - xi. not make any changes or alterations to the accommodation premises without prior approval by local government with such application for approval to be submitted in writing; and
  - xii. only use rooms for their intended purpose; and
  - xiii. establish and maintain a clearly designated office; and
  - xiv. ensure that occupants can contact emergency services at all times; and
  - xv. provide shared or communal areas and facilities and maintain such areas and facilities in a good condition to the satisfaction of an authorised person; and
  - xvi. provide a clean mattress, mattress protector and clean set of clean sheets or clean sheet sleeping envelopes to each occupant on arrival at the accommodation premises; and
  - xvii. ensure all light fittings and other ceiling and wall projections (including ceiling and wall fans) are provided with safety guards or positioned so as not to be a danger to any occupants of a bedroom in the accommodation premises to the satisfaction of an authorised person; and
  - xviii. ensure all rooms are clearly numbered.

## 6. Conditions that will ordinarily be imposed on approvals

The following conditions are conditions that will ordinarily be imposed on an approval where applicable, in the opinion of an authorised person—

- a) The approval holder may be required to –
  - i. Provide kitchen, clothes washing, clothes drying, bathroom rooms, shower and toilet facilities and maintain such facilities in a good condition to the satisfaction of an authorised person; and,
  - ii. provide furniture, fittings, equipment and chattels and maintain such items in a good condition to the satisfaction of an authorised person; and
  - iii. ensure that no cooking or facilities for cooking are allowed in any bedroom of the accommodation premises; and
  - iv. ensure that sleeping bags are not used to sleep on any bed in the accommodation premises; and
  - v. provide a secure, lockable storage area for the purpose of storing occupants' packs and luggage; and
  - vi. ensure that in any bunk, the distance between the surface of
    - A. the lower bed and the base of the upper bed is at least 1m or otherwise agreed by Council; and,
    - B. the upper bed and the ceiling is at least 1m or otherwise agreed by Council; and
  - viii. provide adequate under cover dining room seating for a minimum of 25% of the maximum potential number of occupants at the accommodation premises; and
  - ix. towels and bed linen supplied shall be replaced with clean towels and bed linen before a change of occupancy, or replaced every third day thereafter until occupancy has ceased; and
  - x. provide the following kitchen facilities at the accommodation premises to enable occupants to prepare a substantial meal—
    - A. one hand wash basin with hot and cold water delivered through a common outlet in each kitchen; and,
    - B. refrigerator space with is sufficient to meet the reasonable needs to the maximum potential number of occupants at the accommodation premises; and
    - C. vermin proof dry food storage space which is sufficient to meet the reasonable needs of the maximum potential number of occupants at the accommodation premises; and

D. washing up sinks or dishwashers which are sufficient to meet the reasonable needs of the maximum potential number of occupants at the accommodation premises.

- b) The approval may state—
  - i. the approved use of the rooms; and
  - ii. the number of beds that may be placed and the number of persons who may sleep —
    - A. in a specified room in the premises; or
    - B. in the premises as a whole.

#### **7. Term of approval**

The term of an approval commences on the date the approval is granted and expires on the next 30<sup>th</sup> day of June, unless otherwise specified in the approval.

#### **8. Term of renewal of approval**

The term of a renewal of the approval shall be the term stated in the renewal.

## **Schedule 17      Operation of temporary entertainment events**

section 11

### **1.      Prescribed activity**

Operation of temporary entertainment events.

### **2.      Activities that do not require approval under the authorising local law**

An approval under the authorising local law is not required for—

- (a) opening a house or premises to the public for the purposes of a display of a historic house, a sustainable house or a garden.

### **3.      Documents and materials that must accompany applications for approval**

An application for approval must be accompanied by—

- (a) a copy of any registration, licence, permit or approval required under any other law; and
- (b) if the business or activity is to operate from a vehicle—a full description of that vehicle and its registration number; and
- (c) if the application is for a circus—documentation to demonstrate that the circus complies with the National Consultative Committee for Animal Welfare (NCCAW) *Position Statement Number 26, Recommended National Circus Standards*.

### **4.      Additional criteria for the granting of approval**

The additional criteria for approval are—

- (a) whether the application form has been submitted more than 10 days prior to the event; and
- (b) the physical suitability of the area or road for the proposed event, including access roads servicing the event; and
- (c) the likelihood of the event causing nuisance, inconvenience or annoyance to the occupiers of the adjoining land, vehicular traffic or pedestrians; and
- (d) the likely effect on the amenity of the surrounding area; and
- (e) the likely effect on the local environment and any possible pollution or other environmental damage; and
- (f) the proximity of the activities to other existing commercial businesses; and



- (g) the appropriateness, quality and condition of equipment to be used in the activity; and
- (h) the likely impact on the ability of the general public to use the site concurrently with the proposed activity; and
- (i) the applicant's proposals regarding the provision of shade and shelter to protect against environmental conditions; and
- (j) whether the applicant's proposed waste management strategy makes provision for the satisfactory collection, storage and removal of all waste generated by the proposed activity; and

## **5. Conditions that must be imposed on approvals**

A condition that must be imposed on an approval is that the approval holder must comply with the standard public liability insurance condition.

## **6. Conditions that will ordinarily be imposed on approvals**

For all approvals, the conditions that will ordinarily be imposed on an approval are that the approval holder must—

- (a) permit access to local government staff or contractors at all times to inspect or service facilities; and
- (b) conduct the event in accordance with any standards of the local government applicable at the time of the approval; and
- (c) conduct the event only on the days and times, and at the specific locations or areas, specified in the approval; and
- (d) display the approval in the ways stated in the approval and produce the approval for inspection on demand by an authorised person; and
- (e) comply with measures specified in the approval to protect the safety of persons who may be involved in, or affected by, the activities authorised by the approval; and
- (f) comply with measures specified in the approval to ensure that the activities authorised by the approval do not cause a nuisance; and
- (g) maintain a defined access point for emergency vehicles at all times; and
- (h) if the approval authorises the approval holder to use a specified part of a local government controlled area or road for the event—
  - i. pay rental specified in the approval to the local government at specified intervals; and
  - ii. maintain the area where the activity takes place in clean, tidy and orderly condition; and

- (i) if the activity involves playing live or taped performances—obtain a casual licence from the Australasian Performing Rights Association; and
- (j) if the activity involves use of a footpath—maintain a clear unobstructed pedestrian corridor of not less than 2 metres or, in the case of high usage footpaths, the distance greater than 2 metres stipulated in the approval; and
- (k) comply with relevant workplace health and safety requirements.
- (l) ensure that a sufficient number of security officers are present at all times during the event for crowd control purposes;
- (m) provide a sufficient number of sanitary conveniences for both sexes to the satisfaction of an authorised person;
- (n) ensure that all toilets are to be maintained in a sanitary state during the event to the satisfaction of an authorised person;
- (o) ensure that pyrotechnics displays are carried out by an individual or corporation with the appropriate fireworks licence issued by the relevant statutory body or government department. A current public liability policy must also cover the approval holder, operator and local government in the sum determined by the local government;
- (p) ensure that the stage, including lighting and sound towers, are erected by suitably qualified persons;
- (q) ensure that all temporary electrical work is carried out in accordance with relevant Australian Standards or Industry Codes of Practice;
- (r) ensure that adequate waste receptacles are placed around the venue to meet the reasonable needs of attendees to the satisfaction of an authorised person. Clean-up of waste must be carried out within 24 hours of the event.

For an approval for an event that involves mobile food vending, additional conditions that will ordinarily be imposed on an approval are those set out in section 6(3) of schedule 7 of this subordinate local law.

For an approval for an event that involves roadside vending, additional conditions that will ordinarily be imposed on an approval are those set out in section 6(4) of schedule 7 of this subordinate local law.

For an approval for an event that involves street stalls, additional conditions that will ordinarily be imposed on an approval are those set out in section 6(7) of schedule 7 of this subordinate local law.

For an approval for an event that involves busking, additional conditions that will ordinarily be imposed on an approval are those set out in section 6(8) of schedule 7 of this subordinate local law.

For an approval for a circus, an additional condition that will ordinarily be imposed on an approval are that the circus must comply with the National

*Consultative Committee for Animal Welfare (NCCAW) Position Statement Number 26, Recommended National Circus Standards.*

**7. Term of approval**

The term of an approval commences on the date the approval is granted and expires on the next 30<sup>th</sup> day of June, unless otherwise specified in the approval.

**8. Term of renewal of approval**

The term of a renewal of the approval shall be the term stated in the renewal.

## **Schedule 18      Undertaking regulated activities regarding human remains— (a) disturbance of human remains buried outside a cemetery**

section 11

### **1.      Prescribed activity**

Undertaking regulated activities regarding human remains—(a) disturbance of human remains buried outside a cemetery

### **2.      Activities that do not require approval under the authorising local law**

An approval under the authorising local law is not required for—

- (a) disturbance of human remains on the order of a coroner or other lawful authority.

### **3.      Documents and materials that must accompany applications for approval**

An application for approval must be accompanied by—

- (a) a written statement of reasons for the proposed exhumation; and
- (b) an explanation of the applicant's relationship (if any) to the deceased; and
- (c) written confirmation from a recognised Undertaker that he or she is prepared to carry out the exhumation; and
- (d) written consent to the proposed exhumation by the nearest living relative to the deceased; and
- (e) a certified copy of the Death Certificate; and
- (f) in the case of exhumation for the purposes of reinterment— details of the new burial place where reinterment is to take place; and
- (g) in the case of exhumation for the purposes of cremation—a completed declaration in accordance with the provisions of the *Cremations Act 2003* and the written approval of Queensland Health.

### **4.      Additional criteria for the granting of approval**

The additional criteria for approval are—

- (a) that the exhumation will take place—
  - i. more than 12 months after the original burial of the remains; or

- ii. less than 12 months after the original burial of the remains and—
  - A. special circumstances exist to justify the exhumation; and
  - B. Queensland Health has advised that no health risk will be involved; and
- (b) the nearest living relative consents to the disturbance of the human remains.

**5. Conditions that must be imposed on approvals**

For an approval for exhumation for the purposes of reinterment, a condition that must be imposed on an approval are that the approval holder must—

- (a) place the remains of the deceased in a sealed plastic bag, encased in a hermetically sealed coffin and enclosed in a wooden outer shell or coffin.

**6. Conditions that will ordinarily be imposed on approvals**

*This section has been intentionally left blank.*

**7. Term of approval**

The term of the approval shall be the term stated in the approval.

**8. Term of renewal of approval**

The term of a renewal of the approval shall be the term stated in the renewal.

## **Schedule 19      Undertaking regulated activities regarding human remains— (b) burial or disposal of human remains outside a cemetery**

section 11

### **1.      Prescribed activity**

Undertaking regulated activities regarding human remains— (b) burial or disposal of human remains outside a cemetery

### **2.      Activities that do not require approval under the authorising local law**

*This section has been intentionally left blank.*

### **3.      Documents and materials that must accompany applications for approval**

An application for approval must be accompanied by—

- (a) details of the burial site or other place in which the remains are to be buried or placed; and
- (b) details of when and how the remains are to be disposed of; and
- (c) the written consent of the owner of, and anyone else with a registered interest in, the land on which the remains are to be buried or placed.

### **4.      Additional criteria for the granting of approval**

The additional criteria for approval are that—

- a) the grant of the permit is justified by—
  - i. a special family, personal, cultural or historical association between the deceased person and the place in which the remains are to be buried or placed; or
  - ii. some other special reason; and
- b) the implementation of the proposal will not —
  - i. create a risk to health or other nuisance; and
  - ii. cause reasonable offence to others; and
- c) consent has been given by the owner of the land and anyone else with a registered interest in the land on which the remains are to be buried or placed.

**5. Conditions that must be imposed on approvals**

*This section has been intentionally left blank.*

**6. Conditions that will ordinarily be imposed on approvals**

The conditions that will ordinarily be imposed on an approval are that the approval holder must—

- (a) prepare the grave in accordance with any requirements specified in the approval; and
- (b) allow an authorised person to inspect the grave before burial of human remains in the grave; and
- (c) dispose of the human remains at the particular time or within the particular period specified in the approval;
- (d) erect or install a memorial or marker to identify the site in which human remains have been buried.

**7. Term of approval**

The term of the approval shall be the term stated in the approval.

**8. Term of renewal of approval**

The term of a renewal of the approval shall be the term stated in the renewal.

## **Schedule 20      Undertaking regulated activities regarding human remains— (c) disturbance of human remains in a local government cemetery**

section 11

### **1.      Prescribed activity**

Undertaking regulated activities regarding human remains— (c) disturbance of human remains in a local government cemetery.

### **2.      Activities that do not require approval under the authorising local law**

*This section has been intentionally left blank.*

### **3.      Documents and materials that must accompany applications for approval**

An application for approval must be accompanied by—

- (a) a written statement of reasons for the proposed exhumation; and
- (b) an explanation of the applicant's relationship (if any) to the deceased; and
- (c) written confirmation from a recognised Undertaker that he or she is prepared to carry out the exhumation; and
- (d) written consent to the proposed exhumation by the nearest living relative to the deceased; and
- (e) a certified copy of the Death Certificate; and
- (f) in the case of exhumation for the purposes of reinterment— details of the new burial place where reinterment is to take place; and
- (g) in the case of exhumation for the purposes of cremation—a completed declaration in accordance with the provisions of the *Cremations Act 2003* and the written approval of Queensland Health.

### **4.      Additional criteria for the granting of approval**

The additional criteria for approval are—

- (a) that the exhumation will take place—
  - i. more than 12 months after the original burial of the remains; or



ii. less than 12 months after the original burial of the remains and—

C. special circumstances exist to justify the exhumation; and

D. Queensland Health has advised that no health risk will be involved; and

(b) the nearest living relative consents to the disturbance of the human remains.

**5. Conditions that must be imposed on approvals**

For an approval for exhumation for the purposes of reinterment, a condition that must be imposed on an approval are that the approval holder must—

(a) place the remains of the deceased in a sealed plastic bag, encased in a hermetically sealed coffin and enclosed in a wooden outer shell or coffin.

**6. Conditions that will ordinarily be imposed on approvals**

*This section has been intentionally left blank.*

**7. Term of approval**

The term of the approval shall be the term stated in the approval.

**8. Term of renewal of approval**

The term of a renewal of the approval shall be the term stated in the renewal.

**Schedule 21      Undertaking regulated activities on local government controlled areas and roads—  
(a) driving or leading of animals to cross a road**

section 11

**1.      Prescribed activity**

Undertaking regulated activities on local government controlled areas and roads— (a) driving or leading of animals to cross a road.

**2.      Activities that do not require approval under the authorising local law**

An approval under the authorising local law is not required for—

- (a) a person who has been granted approval for installation of a gate or grid on a road adjacent to the person's land; or
- (b) driving or leading of animals that are not stock animals

**3.      Documents and materials that must accompany applications for approval**

An application for approval must be accompanied by—

- (a) details of how the applicant plans to carry out the activity and the regularity and duration of the activity; and
- (b) details of the location where the activity will be carried out by way of plan or drawing and showing the location of any warning notices for the safety of road users; and
- (c) details of the type and number or approximate number of animals that will be involved.

**4.      Additional criteria for the granting of approval**

The additional criteria for approval are that—

- (a) the physical suitability of the road or footway for the proposed use; and
- (b) the likelihood of the use causing undue nuisance, inconvenience or annoyance to the occupiers of the adjoining land, vehicular traffic or pedestrians; and
- (c) the likely effect on the amenity of the surrounding area; and
- (d) the likely effect on the local environment and any possible pollution or other environmental damage.

**5. Conditions that must be imposed on approvals**

The following conditions are the conditions that must be imposed on an approval holder –

- (a) must comply with the standard public liability insurance conditions;
- (b) restrict the times of day that animals may be led across the road;
- (c) restrict the number of animals that may be driven or led across the road;
- (d) require compliance with safety requirements specified by an authorised person;
- (e) require the approval holder to exhibit specified warning notices and to take other precautions specified by an authorised person for the safety of users of the road or area;

**6. Conditions that will ordinarily be imposed on approvals**

*This section has been intentionally left blank.*

**7. Term of approval**

The term of an approval commences on the date the approval is granted and expires on the next 30<sup>th</sup> day of June, unless otherwise specified in the approval.

**8. Term of renewal of approval**

The term of a renewal of the approval shall be the term stated in the renewal.

## **Schedule 22      Undertaking regulated activities on local government controlled areas and roads— (b) depositing of goods or materials**

section 11

### **1.      Prescribed activity**

Undertaking regulated activities on local government controlled areas and roads— (b) depositing of goods or materials.

### **2.      Activities that do not require approval under the authorising local law**

*This section has been intentionally left blank.*

### **3.      Documents and materials that must accompany applications for approval.**

An application for approval must be accompanied by—

- (a) details of the location of where the activity will be carried out by way of plan or drawing and showing the location of any warning notices for the safety of road users; and
- (b) details of the quantity or volume and type of goods or materials that will be deposited; and
- (c) details of the duration of the depositing of the goods or materials.

### **4.      Additional criteria for the granting of approval**

The additional criteria for approval are—

- (a) the physical suitability of the road or footway for the proposed use; and
- (b) the likelihood of the use causing nuisance, inconvenience or annoyance to the occupiers of the adjoining land, vehicular traffic or pedestrians; and
- (c) the likely effect on the amenity of the surrounding area; and
- (d) the likely effect on the local environment and any possible pollution or other environmental damage; and
- (e) whether the activity will have an adverse effect on an existing service in, on or over a road.

### **5.      Conditions that must be imposed on approvals**

The conditions that must be imposed on an approval are that the approval holder must—

- (a) take out public liability insurance in an amount nominated by the local government and to name local government as an interested party on the policy; and
- (b) indemnify the local government and any other person who has an interest in or takes a benefit from the work or activity against all claims and liability, including claims for personal injury (including death) and damage to property (including economic loss) arising directly or indirectly by, through or in connection with the works or activity; and
- (c) ensure safety of pedestrians and vehicles including but not limited to the safe temporary diversion of traffic, erection of warning lights and barricades to the satisfaction of an authorised person.
- (d) not adversely obstruct the movement of vehicles and pedestrians along the road; and
- (e) ensure that the activity does not cause a nuisance to neighbouring residents; and
- (f) must take all reasonable steps to minimise the effect of the activity on the amenity of the surrounding area (for example, by ensuring the goods or materials are kept in a tidy and orderly manner); and
- (g) not interfere with existing services located in, on or over a road.

**6. Conditions that will ordinarily be imposed on approvals**

The following conditions will ordinarily be imposed on an approval where applicable, in the opinion of an authorised person—

- (a) The approval holder, its contactors or agents may be required to—
  - i. lodge security for performance of any requirement under this local law or any condition of approval; and
  - ii. specify a deadline for completion of the works or ceasing of the activity; and
  - iii. reinstate the road to the satisfaction of an authorised person following completion of the works or ceasing of the activity.

**7. Term of approval**

The term of the approval shall be the term stated in the approval.

**8. Term of renewal of approval**

The term of a renewal of the approval shall be the term stated in the renewal.

## **Schedule 23      Undertaking regulated activities on local government controlled areas and roads— (c) undertaking of a public place activity prescribed by subordinate local law**

section 11

### **1.      Prescribed activity**

Undertaking regulated activities on local government controlled areas and roads— (c) undertaking of a public place activity prescribed by subordinate local law.

### **2.      Activities that do not require approval under the authorising local law**

An approval under the authorising local law is not required for a cake stall, car wash, raffle stall or similar fundraiser where—

- (a) the activity is on a footway adjacent to a road, other than on a median strip; and
- (b) the activity is not within 5 metres of a pedestrian crossing; and
- (c) the activity involves no furniture other than one table with a maximum diagonal length of 2 metres and two chairs; and
- (d) there is a 2 metre unobstructed pedestrian access maintained at all times; and
- (e) there is no cooking or the sale of unpackaged food; and
- (f) there is no sale of live animals; and
- (g) the approval holder has, at all times during the activity, a standard public liability insurance policy for an amount of no less than \$10 million for any single event that covers the approval holder's and the local government's respective rights, interests and liabilities to third parties in respect of accidental death of, or accidental bodily injury to, persons or accidental damage to property; and
- (h) the approval holder indemnifies the local government and the State against all actions, proceedings, claims, demands, costs, losses, damages and expenses which may be brought against, or made upon, the local government or the State as a result of the activity.

### **3.      Documents and materials that must accompany applications for approval**

The following documents and materials must accompany applications for approval –

- (a) Details of the location where the activity will be carried out, by way of plans or otherwise; and if an applicant for approval is not the owner of the premises on which the activity is to be operated, the application must be accompanied by the written consent of the owner; and
- (b) details of contact person; and
- (c) details of times; and
- (d) a copy of the Public Risk Insurance Policy which must be endorsed that the local government is co-insured for their respective rights and interests; and
- (e) relevant additional information which may be required by the local government e.g. stunts, SPX, gunfire, pyrotechnics, road closures, traffic control, set constructions.

#### **4. Additional criteria for the granting of approval**

The additional criteria for approval are that—

- a) adequate provision will be made for traffic movement (both vehicular and pedestrian) and parking in relation to the activity.
- b) whether in the opinion of an authorised person—
  - i. the activity will not unduly interfere with the usual use and enjoyment of the area or road; and
  - ii. that the operation of the activity can be lawfully conducted on the site; and
  - iii. the operation of the activity does not unreasonably detract from the established amenity in the vicinity of the temporary entertainment venue; and
  - iv. the premises are suitable and convenient for use as a temporary entertainment venue taking into account the type of activity proposed, the numbers of persons expected or likely to attend the premises, the location and appearance of the premises and the means of entry and exit for persons and, where applicable, vehicles; and
  - v. the activity complies with the environmental, health and safety standards; and
  - vi. the activity complies with the local government's planning scheme; and
  - vii. the activity will not generate significant noise, dust or light pollution or other significantly adverse effects on the surrounding neighbourhood.

## 5. Conditions that must be imposed on approvals

*This section has intentionally been left blank.*

## 6. Conditions that will ordinarily be imposed on approvals

For all approvals, the conditions that will ordinarily be imposed on an approval are that the approval holder must—

- (a) conduct the activity only on the days and times, and at the specific locations or areas, specified in the approval; and
- (b) display the approval in the ways stated in the approval and produce the approval for inspection on demand by an authorised person; and
- (c) comply with measures specified in the approval to protect the safety of persons who may be involved in, or affected by, the activities authorised by the approval; and
- (d) comply with measures specified in the approval to ensure that the activities authorised by the approval do not cause a nuisance; and
- (e) maintain a defined access point for emergency vehicles at all times; and
- (f) pay any rental specified in the approval to the local government at specified intervals; and
- (g) maintain the area where the activity takes place in clean, tidy and orderly condition; and
- (h) if the activity involves playing live or taped performances—obtain a casual licence from the Australasian Performing Rights Association; and
- (i) if the activity involves use of a footpath—maintain a clear unobstructed pedestrian corridor of not less than 2 metres or, in the case of high usage footpaths, the distance greater than 2 metres stipulated in the approval; and
- (j) comply with relevant workplace health and safety requirements.

For an approval for an activity that involves mobile food vending, additional conditions that will ordinarily be imposed on an approval are those set out in section 6(3) of schedule 7 of this subordinate local law.

For an approval for an activity that involves roadside vending, additional conditions that will ordinarily be imposed on an approval are those set out in section 6(4) of schedule 7 of this subordinate local law.

For an approval for an activity that involves street stalls, additional conditions that will ordinarily be imposed on an approval are those set out in section 6(7) of schedule 7 of this subordinate local law.



---

For an approval for an activity that involves busking, additional conditions that will ordinarily be imposed on an approval are those set out in section 6(8) of schedule 7 of this subordinate local law.

**7. Term of approval**

The term of the approval shall be the term stated in the approval.

**8. Term of renewal of approval**

The term of a renewal of the approval shall be the term stated in the renewal.

---

**Schedule 24      Use of bathing reserves for training,  
competitions etc**

section 11

*This schedule has been intentionally left blank.*

**Schedule 25      Parking contrary to an indication on an  
official traffic sign regulating parking by  
time or payment of a fee**

section 11

*This schedule has been intentionally left blank.*

**Schedule 26      Parking in a loading zone by displaying a  
commercial vehicle identification label**

section 11

*This schedule has been intentionally left blank.*

## **Schedule 27      Carrying out works on a road or interfering with a road or its operation**

section 11

### **1.      Prescribed activity**

Carrying out works on a road or interfering with a road or its operation (*Local Government Act 2009*, section 75(2)).

### **2.      Activities that do not require approval under the authorising local law**

Not applicable.

### **3.      Documents and materials that must accompany applications for approval.**

An application for approval must be accompanied by—

- (a) details of the location where works or activity will be carried out, by way of plans or otherwise; and
- (b) details of any promotional or advertising material intended to be used in connection with the activity; and
- (c) details of any amplification equipment intended to be used in conjunction with the activity.

### **4.      Additional criteria for the granting of approval**

Not applicable.

### **5.      Conditions that must be imposed on approvals**

The following conditions are the conditions that must be imposed on an approval -

- (a) the works or activity must not in the opinion of an authorised person significantly detract from the capacity of the road to provide a vehicular and, where relevant, pedestrian thoroughfare; or
- (b) the works or activity must not in the opinion of an authorised person significantly cause a nuisance or danger to any person or property; or
- (c) the works or activity must not in the opinion of an authorised person significantly obstruct access from the footway to kerbside parking; and
- (d) the works or activity must not in the opinion of an authorised person adversely effect the amenity of the area or the environment; and

- (e) the works or activity must not in the opinion of an authorised person adversely effect existing services located in, on, over or adjacent to a road

**6. Conditions that will ordinarily be imposed on approvals**

The following conditions will ordinarily be imposed on an approval where applicable in the opinion of an authorised person-

- (a) location of such works or activity;
- (b) measure to ensure unobstructed movement of vehicles and pedestrians;
- (c) hours of operation;
- (d) the requirement to take out public liability insurance in an amount nominated by the local government and to name local government as an interested party on the policy;
- (e) indemnification of the local government by the holder of the approval and any other person who has an interest in or takes a benefit from the work or activity against claims for personal injury (including death) and damage to property (including economic loss) arising directly or indirectly by, through or in connection with the works or activity;
- (f) lodgement of security for performance in amount determined by an authorised person;
- (g) specification of a deadline for completion of the works or ceasing of the activity;
- (h) standards to be observed in the carrying out of the works or activity;
- (i) reinstatement of the road to the satisfaction of an authorised person following completion of the works or ceasing of an activity;
- (j) requirements to ensure safety of pedestrians and vehicles including but not limited to the safe temporary diversion of traffic, erection of warning lights and barricades to the satisfaction of an authorised person.

**7. Term of approval**

The term of the approval shall be the term stated in the approval.

**8. Term of renewal of approval**

The term of any renewal is the same term as the original approval subject to compliance with all conditions stated on the approval.

## Schedule 28 Gates and Grids

Section 11

### 1. Prescribed activity

- (1) Installing a gate or a grid, or a gate and a grid, across a road.
- (2) Being a responsible person for a gate or a grid, or a gate and a grid, installed across a road.<sup>7</sup>

### 2. Activities that do not require an approval under the authorising local law

No activities stated.

### 4. Documents and materials that must accompany an application for an approval

- (1) If the installation of a gate or a grid, or a gate and a grid, are proposed—
  - (a) a plan detailing the design of the proposed gate or grid, or gate and grid, including all dimensions, alignments and structural elements; and
  - (b) a plan identifying the location within the road of the proposed gate or grid, or gate and grid; and
  - (c) particulars of all warning or similar signage proposed to be erected by the applicant.
- (2) If a gate or a grid, or a gate and a grid, are installed across a road—
  - (a) a plan detailing the design of the gate or grid, or gate and grid, including all dimensions, alignments and structural elements; and
  - (b) a plan identifying the location within the road of the gate or grid, or the gate and the grid; and
  - (c) details of all warning or similar signage erected about the gate or grid, or the gate and the grid.
- (3) If the gate or grid, or the gate and the grid, are proposed to be installed across a road—details of the time when the prescribed activity will be undertaken.
- (4) The proposed term of the approval.

---

<sup>7</sup> See *Subordinate Local Law No. 4 (Local Government Controlled Areas, Facilities and Roads) 2011*, schedule 2, item 2(b) and (c).

- (5) The impact, if any, of the prescribed activity on pedestrian or vehicular traffic.
- (6) The materials, equipment and vehicles to be used in the undertaking of the prescribed activity.
- (7) A copy of each policy of insurance of the applicant which is applicable to the undertaking of the prescribed activity including, without limitation, a public liability insurance policy which provides indemnity for each individual occurrence in an amount not less than \$10,000,000.00.

#### **4. Additional criteria for the granting of an approval**

The prescribed activity must not—

- (a) result in—
  - i. harm to human health or safety, including the safety of vehicular or pedestrian traffic; or
  - ii. property damage or loss of amenity; or
  - iii. nuisance; or
  - iv. unreasonable obstruction of vehicular or pedestrian traffic; or
  - v. unreasonable prejudice to the proper maintenance of a road; or
  - vi. environmental harm; or
  - vii. environmental nuisance; or
- (b) adversely affect the amenity of the area in which the prescribed activity is to be undertaken.

#### **5. Conditions that must be imposed on an approval**

No conditions prescribed.

#### **6. Conditions that will ordinarily be imposed on an approval**

- (1) The conditions of an approval may require the approval holder to take specified measures to—
  - (a) prevent harm to human health or safety of persons involved in, or affected by, the undertaking of the prescribed activity; and
  - (b) prevent loss of amenity or nuisance resulting from the undertaking of the prescribed activity; and
  - (c) ensure that the undertaking of the prescribed activity does not cause unsafe movement or obstruction of vehicular or



pedestrian traffic.

- (2) If the approval relates to the installation of a gate or a grid; or a gate and a grid — the conditions of the approval may—
  - (a) require compliance with specified safety requirements; and
  - (b) regulate the time within which the installation of the gate or the grid, or the gate and the grid, must be carried out; and
  - (c) specify standards with which the installation of the gate or the grid, or the gate and the grid, must comply; and
  - (d) require the approval holder to—
    - i. carry out specified additional work such as earthwork and drainage work; and
    - ii. take out and maintain public liability insurance as specified by the local government and produce documentary evidence of the insurance to the local government before the installation of the gate or the grid, or the gate and the grid; and
    - iii. give the local government specified indemnities; and
    - iv. construct the gate or the grid, or the gate and the grid, in accordance with standard plans and specifications which the local government may develop or adopt from time to time; and
    - v. maintain structures erected or installed, or vegetation planted, under the approval, in good condition; and
    - vi. clear and maintain the road in the vicinity of the gate or the grid, or the gate and the grid, (including the destruction of plants and vegetation); and
    - vii. remove a gate, grid or structure erected or installed, under the approval, at the end of a stated period; and
    - viii. remove a gate, grid or structure erected or installed, under the approval, if the gate, grid or structure—
      - A. is not effective for its intended purpose; or
      - B. is causing a nuisance, or poses a risk of a nuisance; or
      - C. constitutes an actual, or potential safety hazard; and

- ix. if the approval relates to the installation of a grid—also erect a gate at the location of the grid to a standard, and in accordance with the requirements of, the local government; and
  - x. maintain the road, for a distance of 5m on each side of the grid, in good and sufficient repair –
    - A. so that vehicular and pedestrian traffic is not impeded or obstructed; and
    - B. to prevent or minimise the risk of personal injury or damage to property; and
  - xi. exhibit specified signage warning about the conduct of the prescribed activity on the road; and
  - xii. take specified measures to ensure the unrestricted movement of vehicular and pedestrian traffic along the road during construction and installation of the gate or the grid, or the gate and the grid, as the case may be, and minimise obstruction of vehicular or pedestrian traffic or the risk of personal injury or damage to property; and
  - xiii. keep the gate securely closed whenever the gate is not in immediate use.
- (3) If the approval relates to being a responsible person for a gate or a grid, or a gate and a grid, installed across a road—the conditions of the approval may—
- (a) require compliance with specified safety requirements; and
  - (b) require the approval holder to—
    - i. carry out specified work such as earthwork and drainage work; and
    - ii. take out and maintain public liability insurance as specified by the local government and produce documentary evidence of the insurance to the local government within a stated period; and
    - iii. give the local government specified indemnities; and
    - iv. maintain the gate or the grid, or the gate and the grid, in accordance with standard plans and specifications; and
    - v. maintain structures erected or installed, or vegetation planted, under the approval, in good condition; and
    - vi. clear and maintain the road in the vicinity of the gate or

the grid, or the date and the grid (including the destruction of plants and vegetation); and

- vii. remove a gate, grid or structure identified in the approval, at the end of a stated period; and
  - viii. remove a gate, grid or structure identified in the approval if the gate, grid or structure—
    - A. is not effective for its intended purpose; or
    - B. is causing a nuisance, or poses a risk of a nuisance; or
    - C. constitutes an actual, or potential safety hazard; and
  - ix. if the approval relates to a grid—also erect a gate at the location of the grid to a standard, and in accordance with the requirements of, the local government; and
  - x. maintain the road, for a distance of 5m on each side of the grid, in good and sufficient repair—
    - A. so that vehicular and pedestrian traffic is not impeded or obstructed; and
    - B. to prevent or minimise the risk of personal injury or damage to property; and
  - xi. exhibit specified signage warning about the conduct of the prescribed activity on the road; and
  - xii. keep the gate securely closed whenever the gate is not in immediate use.
- (4) Unless otherwise agreed to gates and grids are to be constructed as per the following specifications:
- (a) Gate specification S1

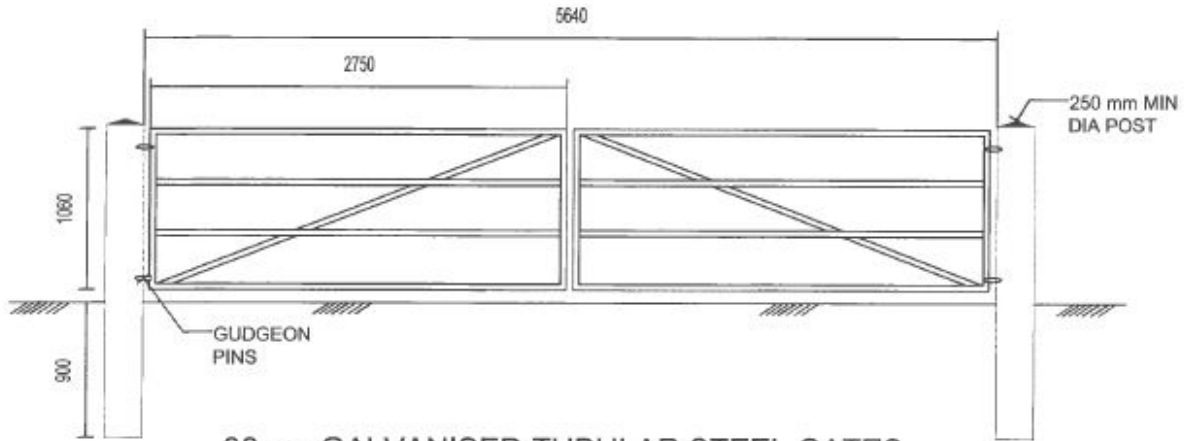

**38mm GALVANISED TUBULAR STEEL GATES**  
SCALE 1:40 @ A4

Two (2) only W5-14A, 600mm x 600mm, Gate Signs



Two (2) only Galvanised Post

Four (4) only Brackets



Gate Signs Spec One

Same as Approach  
→

(b) Gate specification S2

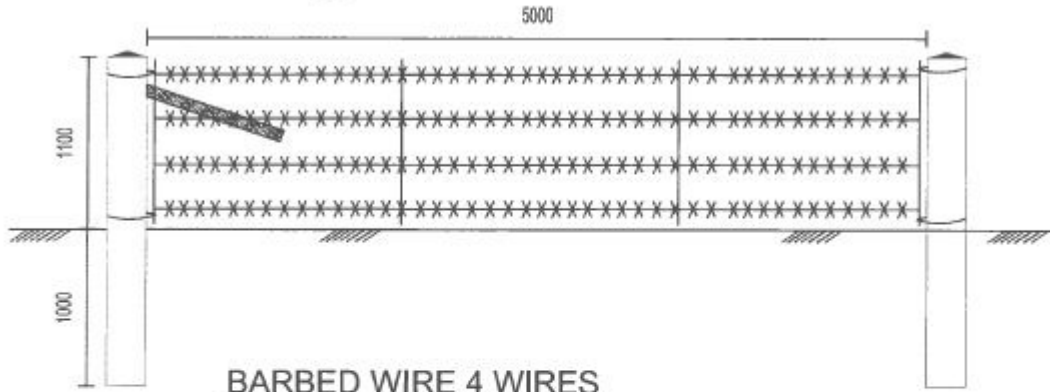

**BARBED WIRE 4 WIRES**  
**MINIMUM STANDARD**  
SCALE 1:40 @ A4

Two (2) only W5-14A, 600mm x 600mm, Gate Signs

Two (2) only Galvanised Post

Four (4) only Brackets

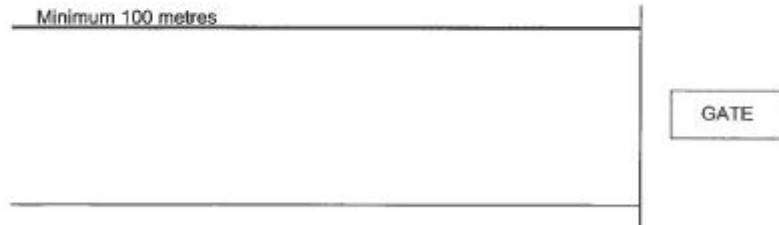

Gate Signs Spec One

Same as Approach →

(c) Grid specification S1

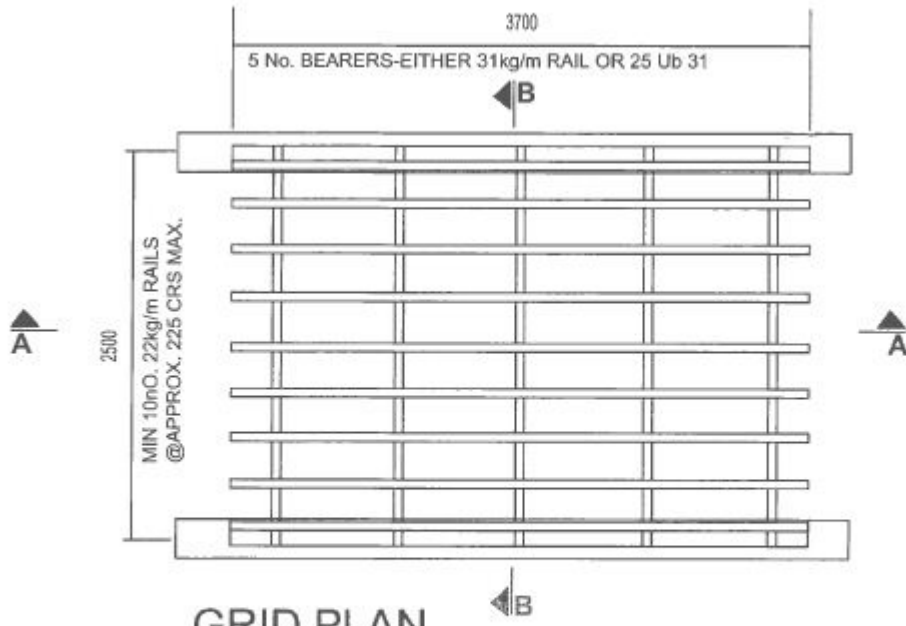

**GRID PLAN**

SCALE 1:40 @ A4

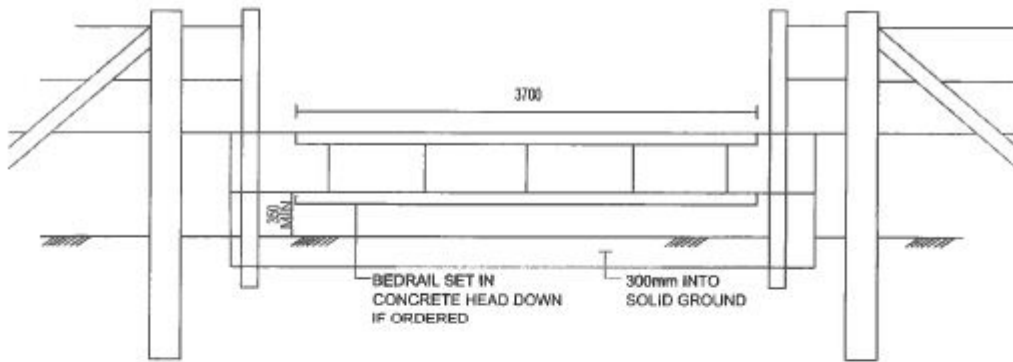

**SECTION A-A**

SCALE 1:50 @ A4

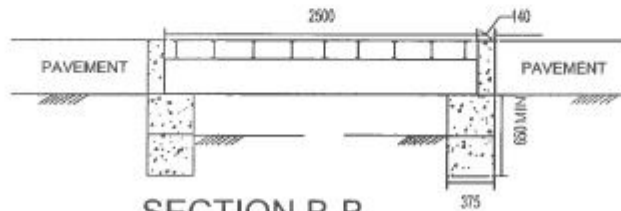

**SECTION B-B**

SCALE 1:50 @ A4

**11. Term of an approval**

- (1) The term of an approval must be determined by the local government having regard to the information submitted by the applicant.
- (2) The term of the approval must be specified in the approval.

**8. Term of renewal of an approval**

- (1) The term for which an approval may be renewed or extended must be determined by the local government having regard to the information submitted by the approval holder.
- (2) If the local government grants the application, the local government must specify in the written notice, the term of the renewal or extension.

## Schedule 29 - Dictionary

**Act** means an Act of the Queensland Parliament;

**accommodation** means a tent or other structure that can be readily assembled and disassembled.

**accommodation** means—

- (a) a caravan; or
- (b) a complementary accommodation.

**advertiser** means a person—

- (a) by whom an advertising device is installed, erected or displayed; or
- (b) whose business or place of business is advertised by an advertising device; or
- (c) who manages and controls, or has power to manage and control, the place at which an advertising device is installed, erected or displayed; or
- (d) who is—
  - i. the owner of premises or a place on which an advertising device is installed, erected or displayed; or
  - ii. the occupier of premises or a place on which an advertising device is installed, erected or displayed; or
  - iii. the owner of a vehicle on which an advertising device is installed, erected or displayed.

**advertising device** means a structure or device which is visible from a road or other public place and which conveys information or directions of any kind (other than a structure or device displayed pursuant to the authority or requirements of an Act) and the term includes any structure forming part of the advertising device or to which the advertising device is attached or on which it is displayed.

**advertisement area** means the total area of an advertisement;

**aerodrome** means a aerodrome within the meaning of the Civil Aviation Act 1988 (Cwlth), section 3.

**aircraft** —

- (a) has the meaning given in the Civil Aviation Act 1988 (Cwlth), section 3; and
- (b) includes any form of fixed wing aircraft or aeroplane, helicopter, ultra light, glider, hang-glider, dirigible, airship, hot air balloon, or any form of craft capable of carrying at least 1 person whilst sustaining itself off the ground.

**ancillary advertisement** means an advertisement which provides information about a business or commercial enterprise or industry conducted on-site. The information may include:

- (a) the use of the site (including the proposed future use of the land);
- (b) the use of a building on the land;



- (c) goods manufactured or offered for sale or hire on the land;
- (d) services offered on the land;
- (e) the name and address of the owner or occupier of the land;
- (f) where a number of persons are carrying on different businesses on the land, an advertisement identifying the place;
- (g) where an event or activity is to be conducted on the land, information about the event or activity.

**animal** has the meaning given in *Local Law No. 2 (Animal Management) 2011*.

**animal entertainment park** means a public place which includes, as part of its entertainment, the exhibiting of animals for the amusement or entertainment of the public.

**Animal Management Act** see *Animal Management (Cats and Dogs) Act 2008*.

**animal sanctuary** means a park, reserve or other place used for the preservation, protection or rehabilitation of animals.

**animated or moving advertisement** means an advertisement that has moving parts or which rotates or revolves. The term includes advertisements containing chasing or running bulbs, reader boards (electronic variable message) and similar features;

**appropriate records** means, as described in Appendix 6 - Records, QLD Health Swimming and Spa Water Quality and Operational Guidelines.

**approved microchip** (for an animal)—

- (a) means a microchip which—
  - i. is capable of being read by the local government's microchip reader; and
  - ii. bears an electronic code which permanently identifies the animal for identification purposes; and
- (b) includes a permanent identification device.

**awning** means a permanent, roof like structure, attached to and projecting from the wall of a building which is generally designed or constructed to provide pedestrians with protection against the weather.

**banner advertisement** means any advertisement:

- (a) suspended from any structure, tree or pole;
- (b) with or without supporting frame work; and
- (c) displaying an advertisement applied to paper, plastic or similar material or fabric of any kind.

The term excludes symbolic flags of any institution or business;

**body corporate** has the meaning given in the *Body Corporate and Community Management Act 1997*.

**building** has the meaning given in the Building Act 1975.

**building work** has the meaning given in the Building Act 1975.

**burial—**

- (a) means the process of placing a body in a coffin or casket and then into the ground and covering it over with soil; and
- (b) a burial can occur in either a lawn section (where a small plaque or monument may be erected at the head of the grave) or in a monumental section (where a monument partially or completely covers the grave).

**bunting** includes decorative flags, pennants and streamers;

**bus zone** has the meaning given in the Transport Operations (Road Use Management – Road Rules) Regulation 2009.

**cabin** means a relocatable home, building or fixed structure (other than a building or structure used exclusively as the residence or office of a resident manager).

**camp site** means a part of a camping ground which is designated for occupation by a tent, inclusive of ropes, poles, supports and pegs incidental to the erection and use of the tent.

**code assessable development** means development the subject of code assessment.

**code assessment** has the meaning given in the *Sustainable Planning Act 2009*.

**columbarium** means an arrangement of niches that may include a wall or an entire building, with niches for the entombment of cremated remains.

**commercial camping ground** means land that is made available, on a commercial basis, for camping but does not include a caravan park.

**common area** has the meaning given in schedule 1, section 3(4).

**community organisation sign** see schedule 3, section 2.

**community service organisation** means an incorporated association which is incorporated under the *Associations Incorporation Act 1981* which has as the main purpose of its objects, making financial gain for community service, charitable or similar purposes.

**community titles scheme** has the meaning given in the *Body Corporate and Community Management Act 1997*.

**complementary accommodation** means the other accommodation that is prescribed as appropriate to caravan parks is accommodation is –  
on-site caravan; and,

- a cabin; and,
- a manufactured home; and,

- a tent or other structure that can be readily assembled and disassembled.

**construction advertisement** means a temporary advertisement used to identify the name of a development or developer during the construction of a development.

**cremated remains** means the remains after the cremation process is completed.

**crypt** means an "in-ground" or "above-ground" burial chamber constructed of steel-reinforced concrete, gravel, and other waterproof materials that uses a drainage system to keep moisture out.

**development approval** has the meaning given in the *Sustainable Planning Act 2009*.

**electrical installation** has the meaning given in the *Electricity Act 1994*.

**entertainment event**— has the meaning given in the authorising local law; but

- (a) for the avoidance of doubt, includes—
  - i. an event at a convention centre, major sporting facility or stadium that is open to the public for entertainment whether or not a charge for admission is made and whether or not the person who controls admission to the place reserves a right to refuse admission; and
  - ii. one-off events, for example, a religious meeting at a local government controlled area, sporting venue, amplified music concert, promotional event, live performance, concert, festival or skate park event if the event is open to the public for entertainment whether or not a charge for admission is made and whether or not the person who controls admission to the place reserves a right to refuse admission; and
  - iii. an event at a place which has the potential to affect the amenity of premises which are contiguous to, or within the vicinity of, the place, if the event is open to the public for entertainment whether or not a charge for admission is made and whether or not the person who controls admission to the place reserves a right to refuse admission; and
  - iv. an event that has a potential to cause environmental harm, impact on public health or cause a nuisance if the event is open to the public for entertainment whether or not a charge for admission is made and whether or not the person who controls admission to the place reserves a right to refuse admission.

**entombment** means the placement of human remains in a crypt.

**environmental harm** has the meaning given in the *Environmental Protection Act 1994*.

**environmental nuisance** has the meaning given in the *Environmental Protection Act 1994*.

**estate entrance advertisement** means an advertisement placed or erected at the entrance to an industrial or residential development, identifying the particular development;

**estate sales office** means any premises including a caravan or relocatable home on which a sign is exhibited for the promotion and/or sale of land within an industrial or residential development, where the use of such facilities shall not be more than two (2) years from the date of commencement, unless approved by Council;

**facilities** includes—

- (a) toilets; and
- (b) bathing and showering facilities; and
- (c) facilities for washing and drying clothes; and
- (d) facilities for cooking and food preparation; and
- (e) sporting and other recreational facilities; and
- (f) other facilities for the use or convenience of people using a camping ground.

**fascia advertisement** means an advertisement which is affixed to, posted or painted on a fascia of a building, such that the advertisement protrudes no more than 100mm from the surface to which it is attached.

**fire safety installation** has the meaning given in the *Building Act 1975*.

**Footpath** has the meaning given in the Transport Operations (Road Use Management) Act 1995.

**footpath garden** means—

- (a) the use of a part of a footpath for growing vegetation, for example, flowers, for ornamental or public enjoyment purposes; but
- (b) does not include the growing of vegetation which is—
  - i. a tree; or
  - ii. a shrub having a height of 1.5m or more above ground level directly adjacent to the shrub.

**freestanding advertisement** means an advertisement which:

- (a) is erected on a pole or poles, or on a pylon structure ("a freestanding pole advertisement"); or
- (b) a solid, free standing structure, and does not form part of any building or other structure.

**free-standing sign** means a sign which does not form part of a building or other structure which is erected on—

- (a) a pole or poles, or a pylon structure; or
- (b) a solid, free-standing structure.

**gate** means a hinged or sliding barrier used to close an opening in a wall, fence or hedge.

**goods** includes wares, merchandise, chattels, money, stone, timber, metal, fluid and any other article, substance or material whatsoever.

**grave** means an area of land at a cemetery used or intended to be used for the burial of human remains.

**grid** has the meaning given in *Subordinate Local Law No. 4 (Local Government Controlled Areas, Facilities and Roads) 2011*.

**hazard warning lights** has the meaning given in the *Transport Operations (Road Use Management – Road Rules) Regulation 2009*.

**height** means the distance measured between the top of an advertising device and ground level directly adjacent to the advertising device.

**home activity advertisements** means an advertisement associated with a lawful home activity.

**home based business advertisements** means an advertisement associated with a lawful home based business.

**illuminated**, for an advertising device, means that the advertising device has specifically designed internal, or external or both internal and external, means of illumination of the whole or a portion of the advertising device.

**impact assessable development** means development the subject of impact assessment.

**impact assessment** has the meaning given in the *Sustainable Planning Act 2009*.

**incorporated association** has the meaning given in the Associations Incorporation Act 1981

**inflatable sign** see schedule 3, section 11

**interment** means—

- (a) the burial of human remains or placement of the human remains in an above ground mausoleum or vault; or
- (b) the placement of cremated ashes in a grave, columbarium, rose garden or vault.

**interment site**—

- (a) means a grave, crypt, niche, vault or rose garden; and
- (b) for the avoidance of doubt, no proprietary rights attach to an interment site.

**land** has the meaning given in the *Sustainable Planning Act 2009*.

**loading zone** has the meaning given in the *Transport Operations (Road Use Management) Act 1995*

**local government public health risk** has the meaning given in the *Public Health Act 2005*.

**manufactured home** has the meaning given in the *Manufactured Homes (Residential Parks) Act 2003*.

**mausoleum** —

- (a) means an above ground structure for interment of human remains; and
- (b) a mausoleum may contain a combination of crypts, niches or columbaria.

**memorial** includes—

- (a) a headstone; and
  - (b) an inscribed plaque or commemorative plate; and
- monumental, ornamental or other structures erected on a grave site; and anything else erected or placed to mark the site where human remains have been buried or placed, or to commemorate a deceased person.

**mobile roadside vending** means an operator soliciting or carrying on the supply of goods or services (including food or drink) for profit in circumstances where—

- (a) the operator travels from place to place; and
- (b) the operator supplies the goods or services to a customer in response to the customer waving down the operator.

**monument** means a memorial made principally of stone which extends above the surface of the earth, in upright form.

**motor vehicle** has the meaning given in the *Transport Operations (Road Use Management) Act 1995*.

**multi-residential premises** has the meaning given in *Subordinate Local Law No. 2 (Animal Management) 2011*.

**niche** means a space in a mausoleum or columbarium used or intended to be used for the interment of cremated remains.

**noise sensitive location** means a location that is affected by noise.

**obstacle limitation surface**—

- (a) means the series of surfaces established by the local government in the air space around an aerodrome which limit the height above ground level of objects surrounding the aerodrome; and
- (b) an object which projects through the obstacle limitation surface for an aerodrome becomes an obstacle to the operation of aircraft at the aerodrome.

**occupant** (of accommodation) means a person who resides at the accommodation.

**occupier**, of premises—

- (a) means the person who has the control or management of the premises; and
- (b) includes the owner of the premises where there is no person in apparent occupation of the premises.

**on-site sewerage facility** has the meaning given in the *Plumbing and Drainage Act 2002*.

**operator**, of a camping ground, means the person carrying out, undertaking or otherwise engaging in the operation of the camping ground.

**operator**, of a public swimming pool, means the person carrying out, undertaking or otherwise engaging in the operation of the public swimming pool.

**over awning advertisement** means an advertisement which is located on top of an awning, verandah or canopy with no part of the advertisement projecting above the roofline or beyond the awning, canopy or verandah edge;

**owner** (of an animal) has the meaning given in *Local Law No. 2 (Animal Management) 2011*.

**owner** (of land) includes—

- (a) the registered proprietor of freehold land; and
- (b) the purchaser of land to be held as freehold land that is being purchased from the State under an Act; and
- (c) the holder of a leasehold interest from the State; and
- (d) the holder of a mining claim or a mining lease to which the *Mineral Resources Act 1989* applies; and
- (e) another person who is entitled to receive the rent for the land.

**owner** (of premises) means the person for time being entitled to receive the rent for the premises or who would be entitled to receive the rent for it if it were let to a tenant at a rent.

**permanent identification device** has the meaning given in the Animal Management Act.

**planning area** as defined by the applicable town planning schemes for the area.

**plant** has the meaning given in the *Land Protection (Pest and Stock Route Management) Act 2002*.

political advertisement **means a temporary advertisement exhibited for the purposes of an election;**

**portable advertisement** means a freestanding moveable advertisement placed on the footpath, road reserve or other public place. The term includes sandwich and spinning boards;

**potable water** means water which complies with the Australian Drinking Water Guidelines.

**premises** means the premises used for the operation of the caravan park.

**premises** has the meaning given in *Subordinate Local Law No. 2 (Animal Management) 2011*.

**proper enclosure** has the meaning given in *Local Law No. 2 (Animal Management) 2011*.

**public place** has the meaning given in *Local Law No. 1 (Administration) 2011*.

**projecting advertisement** means an advertisement attached to and protruding more than 100mm either vertically, or horizontally from a building or structure, but not attached to the roof of a building or structure;

**public information advertisement** means an advertisement erected or displayed to indicate the location of a public building, service or place of interest, and which carries no other information or advertisement;

**public place** has the meaning given in the authorising local law.

**public swimming pool** means a swimming pool that is made available for use to —

- (a) members of the public or a section of the public; or
- (b) participants in organised swimming or diving competitions or in training for organised swimming or diving competitions; or
- (c) persons who have a commercial relationship with the owner of the pool.

**real estate advertisement** means a temporary advertisement on-site, advising of the owner's intention to sell, lease, tender or auction the land and/or building;

**recyclable waste** has the meaning given in the *Environmental Protection (Waste Management) Regulation 2000*.

**relocatable home** means a Class 1 or Class 3 building under the Building Code of Australia (or its equivalent) which is—

- (a) constructed away from the site at which it is erected; and
- (b) designed to be moved from 1 location to another; and
- (c) ordinarily able to be moved within 24 hours of commencement of work associated with the move.

**resident** (of a caravan park) means a person who resides in a caravan or complementary accommodation at the caravan park.

**resident manager** (of a caravan park) means—

- (a) a person nominated by the approval holder and accepted by the local government from time to time who—
  - i. is responsible for the management and supervision of the caravan park; and
  - ii. resides on or near the caravan park; and
- b. is present or available at all reasonable times to ensure the operation of the caravan park; and
- (b) if that person cannot be located, or if no such person is nominated and accepted, the approval holder.

**responsible person** has the meaning given in *Subordinate Local Law No. 4 (Local*



*Government Controlled Areas, Facilities and Roads) 2011.*

**road**—

- (a) has the meaning given in the authorising local law; and
- (b) includes—
  - i. an area of land that—
    - A. is developed for, or has as 1 of its main uses, the driving or riding of motor vehicles; and
    - B. is open to, or used by, the public; and
  - ii. a footpath or bicycle path.

**rose garden** means an interment site for the placement of cremated remains.

**roof** means the protective covering, that covers or forms the top of a building.

**sale** includes —

- (a) to sell; and
- (b) sell for resale; and
- (c) offer, or expose for sale; and
- (d) agree or attempt to sell; and
- (e) receive, keep or have in possession for sale; and
- (f) cause or permit to be sold or offered or exposed for sale; and
- (g) provide a sample; and
- (h) barter; and
- (i) auction; and
- (j) supply or have available for supply; and
- (k) suffer or permit any of the above acts.

**sanitary convenience** has the meaning given in the *Environmental Protection Act 1994*.

**service provider** means a supplier of a utility service, for example, water, hydraulic power, electricity, gas, sewerage or drainage services, or telecommunications services.

**self assessable development** has the meaning given in the *Sustainable Planning Act 2009*.

**sewerage system** has the meaning given in the *Plumbing and Drainage Act 2002*.

**shroud** means a length of cloth or an enveloping garment in which a dead person is wrapped for burial.

**sign** see advertising device.

**site** means a part of a caravan park which is designated for a single accommodation of a particular type.

**site community organisation sign** see schedule 3, section 3.

**sporting field** means land used for a sport or game and includes a golf course.

**sporting field fence sign** see schedule 3, section 12.

**statutory sign** see schedule 3, section 7.

**street front boundary** —

- (a) of premises, means the length, measured in metres, along the alignment of the premises abutting a road or abutting an access restriction strip directly between the premises and a road; and
- (b) if premises continuously abut more than 1 road or access restriction strip directly between the premises and a road, the street front boundary dimensions shall be the total length of those boundaries added together; and
- (c) if premises have more than 1 street front boundary that is not continuous, each street front boundary is to be considered separately.

**structure** has the meaning given in the Act.

**stationary roadside vending** means an operator soliciting or carrying on the supply of goods or services (including food or drink) for profit in circumstances where—

- (a) the operator carries on the activity from—
  - i. a specified place; or
  - ii. a number of specified places; but
- (b) the activity is not footpath dining.

**structure** has the meaning given in the Local Government Act 2009.

**swimming pool** has the meaning given in the *Building Act 1975*.

**temporary advertisement** means an advertisement which, by its nature, is intended to be in place for only a limited amount of time, not exceeding three months. The term includes:

- (a) a political advertisement;
- (b) a real estate advertisement; or
- (c) an advertisement for the sale, lease, tender or auction of a product.

**tout** —

- (a) means draw to the attention of, or make known to, a person in a public place, verbally or in writing, a business or commercial activity; and
- (b) touting has a corresponding meaning.

**transom advertisement** means an advertisement attached to the transom, horizontal beam, of a doorway in a building;

**trade waste** has the meaning given in the *Water Supply (Safety and Reliability) Act 2008*.

**under awning advertisement** means an advertisement which is attached to the underside of an awning, verandah, or canopy;

**vault** means a compartment in a mausoleum, or an underground chamber, in which human remains are, or may be, interred.

**vegetation** means trees, shrubs, plants and all other organisms of vegetable origin (whether living or dead).

**vermin** means—

- (a) reptiles, bed bugs, lice, fleas, parasites and cockroaches; and
- (b) guinea pigs and other rodents capable of carrying or transmitting a notifiable disease; but
- (c) does not include—
  - i. a protected animal within the meaning of the *Nature Conservation Act 1992*; or
  - ii. a local government public health risk.

**vehicle** has the meaning given in the *Transport Operations (Road Use Management) Act 1995*.

**vehicle** means any air cushion vehicle, articulated vehicle, bicycle, caravan trailer, commercial vehicle, motor car, motor cycle, motor omnibus, motor truck, motor utility, truck, motor vehicle, omnibus, side car, tractor, trailer, tricycle or vehicle as defined in section 9 of the *Traffic Act*,

**virtual memorial** means an online memorial web site that celebrates the personal life story of a departed loved one.

**wall advertisement** means an advertisement which is affixed to, posted or painted on a wall surface of a building, such that the advertisement protrudes no more than 100mm from the wall to which it is attached. The term excludes fascia, or transom advertisements;

**waste** has the meaning given in the *Environmental Protection Act 1994*.

**waste container** means a container for the storage of waste that is—

- (a) weather proof; and
- (b) readily able to be cleaned; and
- (c) leak proof; and
- (d) constructed of durable material.

**waste water** means liquid waste.

**water supply system** has the meaning given in the *Standard Plumbing and Drainage Regulation 2003*.

**waters** includes—

- (a) surface waters (including water flowing in a water course); and
- (b) ground waters; and

- (c) the bed and banks of waters.

**window advertisement** means an advertisement which is attached to or displayed on the exterior or interior surface of a window. The term includes a device which is suspended from the window frame and may also be illuminated, and excludes product displays or showcases viewed by pedestrians.

## **Certification by Chief Executive Officer**

This and the preceding one hundred and sixteen (116) pages bearing my initials is a certified copy of Subordinate Local Law No. 1 (Administration) 2011 made, in accordance with the provisions of the *Local Government Act 2009* by the North Burnett Regional Council by resolution on 6 December 2011.

MJP PITT  
Chief Executive Officer